

Vision Sensor

VG Series

User Manual



Preface





Thank you for purchasing an Autonics product.

This user manual contains information about the product and its proper use, and should be kept in a place where it will be easy to access.

User Manual Guide

- Please familiarize yourself with the information in this manual before using the product.
- This manual provides detailed information on the product's features. It does not offer any guarantee concerning matters beyond the scope of this manual.
- This manual may not be edited or reproduced in either part or whole without permission.
- This programming manual is not provided as part of the product package. Please visit our home-page (www.autonics.com) to download a copy.
- The manual's content may vary depending on changes to the product's software and other unforeseen developments within Autonics, and is subject to change without prior notice. Upgrade notice is provided through our homepage.
- We contrived to describe this manual more easily and correctly. However, if there are any corrections or questions, please notify us these on our homepage.

User Manual Symbols

Symbol	Description
 Note	Supplementary information for a particular feature.
 Warning	Failure to follow instructions can result in serious injury or death.
 Caution	Failure to follow instructions can lead to a minor injury or product damage.
 Ex.	An example of the concerned feature's use.
※1	Annotation mark.

Safety Considerations

- Following these safety considerations will ensure the safe and proper use of the product and help prevent accidents, as well as minimizing possible hazards.
- Safety considerations are categorized as Warnings and Cautions, as defined below:

 Warning	Warning	Failure to follow the instructions may lead to a serious injury or accident.
--	----------------	--

 Caution	Caution	Failure to follow the instructions may lead to a minor injury or accident.
--	----------------	--



Warning

- Fail-safe device must be installed when using the unit with machinery that may cause serious injury or substantial economic loss. (e.g. nuclear power control, medical equipment, ships, vehicles, railways, aircraft, combustion apparatus, safety equipment, crime/disaster prevention devices, etc.)
Failure to follow this instruction may result in personal injury, fire, or economic loss.
- Do not use this product for protecting human body or part of body.
- Do not see light LED directly or direct beam at person.
Failure to follow this instruction may result in damage on eyes.
- Do not connect, repair, or inspect the unit while connected to a power source.
Failure to follow this instruction may result in fire.
- Check connections and connect cables.
Failure to follow this instruction may result in fire.
- Do not disassemble or modify the unit.
Failure to follow this instruction may result in fire.



Caution

- Use the unit within the rated specifications.
Failure to follow this instruction may result in fire or product damage.
- Use dry cloth to clean the unit. Do not use water or organic solvent when cleaning the unit.
Failure to follow this instruction may result in fire.
- Do not use the unit where flammable/explosive/corrosive gas, humidity, direct sunlight, radiant heat, vibration, impact or salt may be present.
Failure to follow this instruction may result in fire or explosion.
- Keep metal chip, dust and wire residue from flowing into the unit.
Failure to follow this instruction may result in fire or product damage.

The above specifications are subject to change and some models may be discontinued without notice.

Be sure to follow cautions written in the instruction manual, user manual and the technical descriptions (catalog, homepage).

Caution during Use

- Follow instructions in Cautions during Use. Otherwise, it may cause unexpected accidents.
- 24VDC power supply should be insulated and limited voltage/current or Class 2, SELV power supply device.
- In order to avoid malfunction from static electricity or noise, ground shield wire of the power I/O cable.
- Do not disconnect the power supply while setting operation or saving set information. It may cause data loss.
- Do not disconnect the power supply while updating firmware. It may cause product damage.
- Keep optical section of the sensor away from the contact with water, dust and oil. It may cause malfunction.
- When changing the light or filter, use the assembly tool and observe installation instruction.
- When the sensor is not used for a long time, separate the power cable to store.
- When connecting network, connection must be operated by technical expert.
- In the following case, disconnect the power supply immediately. It may cause fire or product damage.
 - ① When water or foreign substance is detected in the product
 - ② When the product is dropped or case is damaged
 - ③ When smoke or smell is detected from the product
- Do not use the product in the place where strong magnetic field or electric noise is generated.
- This unit may be used in the following environments.
 - ① Indoor (in the environment conditions in specifications)
 - ② Altitude max. 2,000m
 - ③ Pollution degree 2
 - ④ Installation category II

Table of Contents

Preface	iii
User Manual Guide	iv
User Manual Symbols	v
Safety Considerations	vi
Caution during Use.....	vii
Table of Contents	ix
1 Product Instruction.....	11
1.1 Features.....	11
1.2 Accessory and sold separately.....	12
1.2.1 Overall configuration diagram	12
1.2.2 Accessory.....	13
1.2.3 Sold separately.....	14
1.3 Ordering Information.....	16
1.4 Unit Description	17
2 Specifications.....	19
3 Dimensions.....	21
3.1 Body.....	21
3.2 Bracket.....	21
3.2.1 Bracket A (BK-VG-A).....	21
3.2.2 Bracket B (BK-VG-B)	21
3.3 Cable.....	22
3.3.1 Power I/O cable.....	22
3.3.2 Ethernet cable	22
4 Connections	23
4.1 Power I/O Cable (M12 12-pin connector).....	24
4.1.1 Input	25
4.1.2 Output (OUT0 to OUT3).....	25
4.2 Ethernet Cable (M12 8-pin/RJ45 connector).....	26
5 Installation	27
5.1 Working Distance and FOV by Effective Focal Length	28
5.2 Installation of Vision Sensor	29
5.3 Focus Adjustment.....	29
5.4 Replacement of Light and Filter.....	30
5.4.1 Replacement of color filter or polarizing filter.....	30
5.4.2 Replacement of light	31
6 Vision Sensor Program [Vision Master].....	33
6.1 Overview	33
6.2 Vision Master Work Flow	37
6.2.1 Setting mode	37

6.2.2	Operation mode.....	38
6.3	Installation of Vision Master.....	39
6.3.1	System requirements	39
6.3.2	Installation of the program.....	39
6.3.3	Installation folder structure	43
6.3.4	Removal of the program.....	43
6.3.5	Network setting.....	44
6.4	Start and Exit	47
6.4.1	Start	47
6.4.2	Exit.....	47
6.5	Vision Master Screen Layout.....	48
6.5.1	Menu.....	50
6.5.2	Toolbar.....	53
6.6	Setting Menu.....	57
6.6.1	Network	57
6.6.2	Camera.....	60
6.6.3	Input.....	66
6.6.4	Output.....	70
6.6.5	Work Group	73
6.6.6	Inspection	77
6.7	Inspection.....	80
6.7.1	Alignment	81
6.7.2	Brightness	85
6.7.3	Contrast.....	87
6.7.4	Area	89
6.7.5	Edge.....	91
6.7.6	Shape comparison	94
6.7.7	Length.....	96
6.7.8	Angle	98
6.7.9	Diameter.....	100
6.7.10	Object counting	103
6.7.11	Color identification.....	106
6.7.12	Area of color	109
6.7.13	Object of color counting.....	112
7	Settings.....	115
7.1	Simulator.....	116
7.2	Device (Vision Sensor).....	119
8	Troubleshooting	123

1 Product Instruction

1.1 Features

VG series, vision sensor, is the light and sensor integrated type which has 13 types of inspection functions, so that it can be applied and utilized for various environment and condition. Before applying to actual environment to utilize, using simulator can realize inspection.

Since it is available to set 32 work groups and 64 inspection items for each work group, vision sensor can flexibly response to the change of work environment.

Furthermore, parameter setting and monitoring from PC is simple through Ethernet communication.

- Light integrated vision sensor
- Minimized image distortion with global shutter method
- Proprietary technology to block optical interference to improve optical performance (patent)
- Stronger in environment of vibration or impact with lens cover detachment prevention technology
- Various inspection function: alignment, brightness, contrast, area, edge, shape comparison length, angle, diameter, object counting, color identification, area of color, object of color counting
- Flexible response to changing work environment by setting 32 work groups (64 inspection items for each work group)
- Easy work group managing and parameter setting
: Through vision sensor program (Vision Master), it is available to copy or save work group saved in vision sensor to PC or work group saved in PC to vision sensor.
- Real-time monitoring of inspection result
: Through vision sensor program (Vision Master), it is available to monitor the Pass/Fail inspection result of inspection items in real-time. Furthermore, statistics data of the inspection result can be generated, and it can be also initialized during inspection.
- Realization of inspection by simulator
: Through vision sensor program (Vision Master), it is available to register work group with an image saved in PC to test inspection, without vision sensor.
- Saving data to FTP server
: According to the settings, an inspection result image can be transmitted and saved in FTP server. Furthermore, setting the file naming rule can help to manage file.
- Applicable to various environment with various light and filter
 - 4 types of light (white/red/green/blue)
 - 4 types of color filter (red/green/blue/infrared blocking)
 - Polarizing filter (window/red/green/blue/infrared blocking)
- Protection structure IP67 (IEC standard)

1.2 Accessory and sold separately

1.2.1 Overall configuration diagram

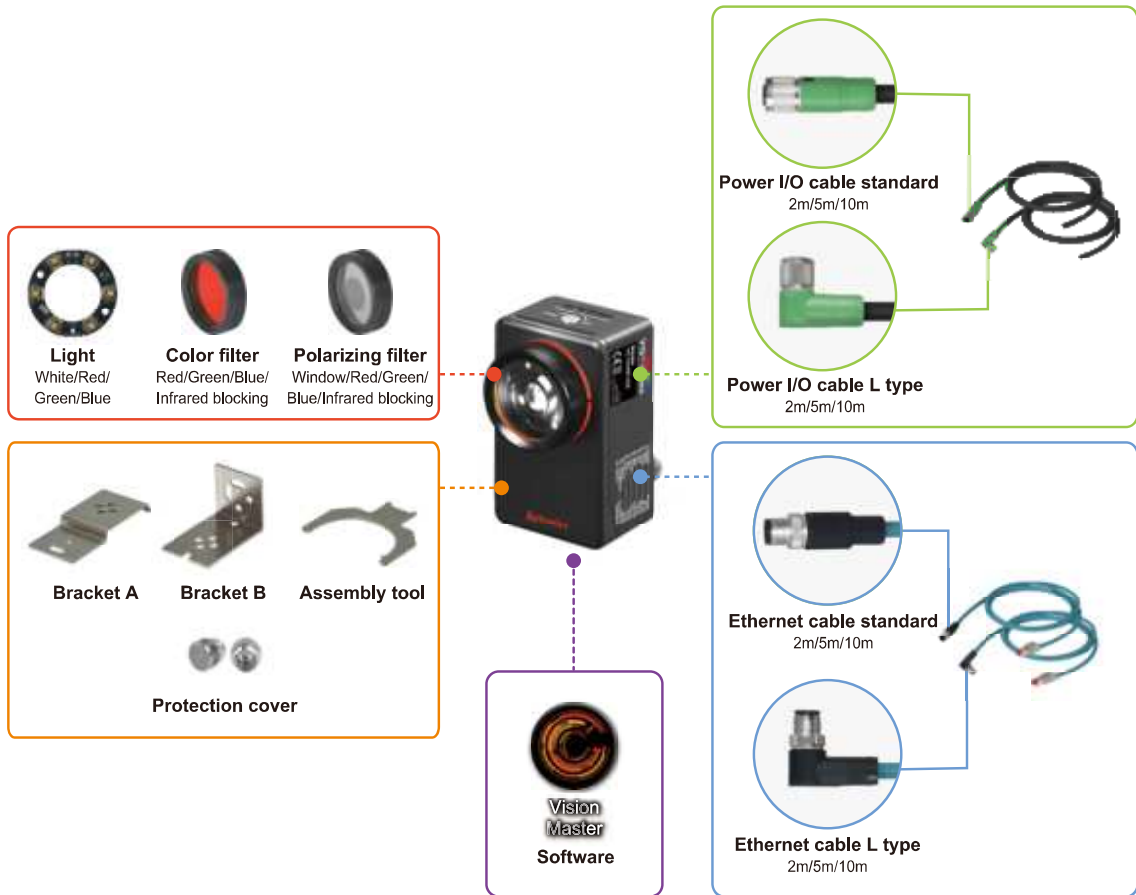

1.2.2 Accessory

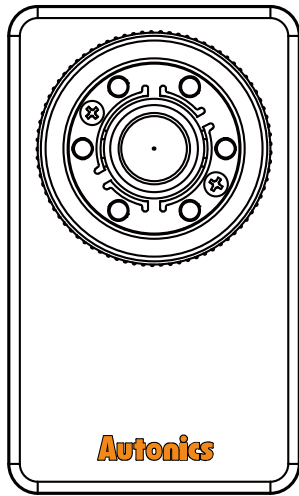

VG body

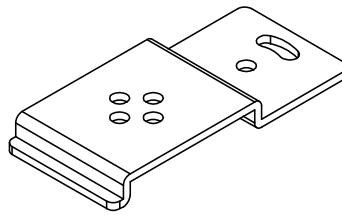

Bracket A



Mounting screw: 2

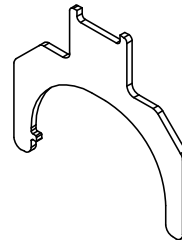

Assembly tool

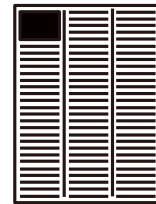

Instruction manual



Note

- Visit our homepage (www.autonics.com) to download vision sensor program (Vision Master).
- Before using the product, please check whether all accessories above are included. If there is a damaged or missing accessory, please contact Autonics sales team or retailer.



Note

Please refer to the model name below, when purchasing the lost accessory.

- Assembly tool



- Bracket A



1.2.3 Sold separately

- Light*

LR-W-06-VG (white)	LR-R-06-VG (red)	LR-G-06-VG (green)	LR-B-06-VG (blue)
			

※Besides offered light, another type of lights are sold separately.



- Color filter

FL-R-VG (red)	FL-G-VG (green)	FL-B-VG (blue)	FL-IC-VG (infrared blocking)
			



- Polarizing filter

FL-P-VG (window)	FL-RP-VG (red)	FL-GP-VG (green)	FL-BP-VG (blue)	FL-ICP-VG (infrared blocking)
				

- Power I/O cable

CID-2-VG (length: 2m) CID-5-VG (length: 5m) CID-10-VG (length:10m)	CLD-2-VG (length: 2m) CLD-5-VG (length: 5m) CLD-10-VG (length:10m)
	

- Ethernet cable

CIR-2-VG (length: 2m) CIR-5-VG (length: 5m) CIR-10-VG (length:10m)	CLR-2-VG (length: 2m) CLR-5-VG (length: 5m) CLR-10-VG (length:10m)
	

- Protection cover[※]

P96-M12-1



- Bracket B

BK-VG-B

※Protection cover protects unused connectors from foreign substances.

When installing the protection cover, please tighten the cover with hand.

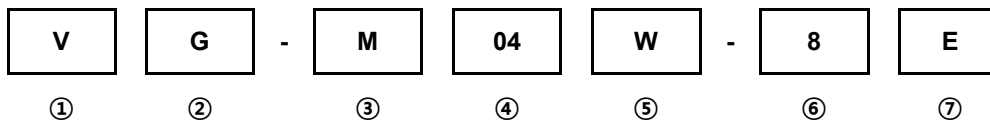
1.3 Ordering Information



Items	Description	
① Item	V	Vision sensor
② Type	G	General inspection
③ Image element	M	Mono CMOS
	C	Color CMOS
④ Resolution (pixel)	04	752×480
⑤ Light	W	White
	R	Red
	G	Green
	B	Blue
⑥ Effective focal length	8	8mm
	16	16mm
	25	25mm
⑦ Communication	E	Ethernet (TCP/IP)

※1. Light can be purchased separately.

1.4 Unit Description

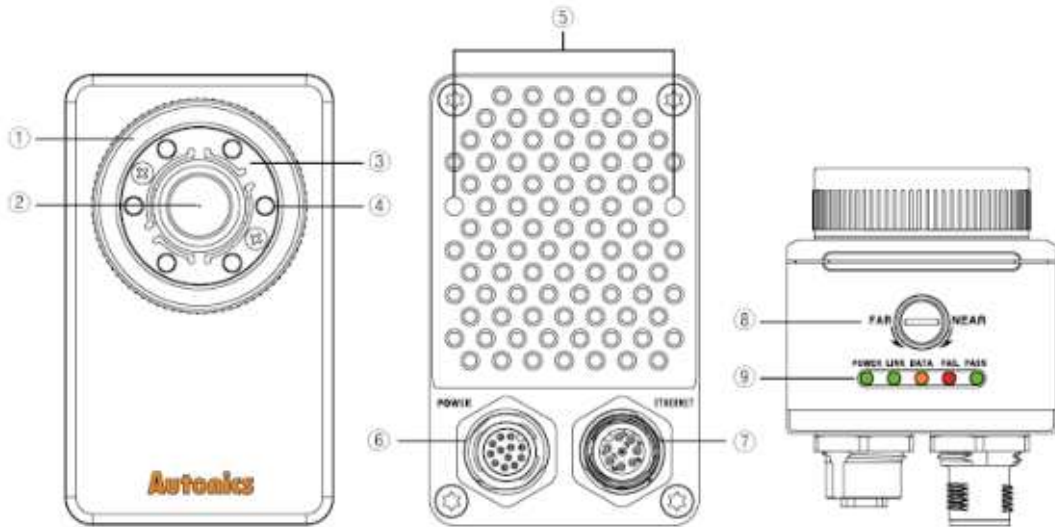

- ① Lens cover: Front cover of lens
 ※In case using a filter (color filter/polarizing filter), separate the lens cover with the assembly tool before insert the filter.
- ② Lens: There are 8mm, 16mm, 25mm models by effective focal length.
- ③ Light cover: Light cover fixes inner LED lights.
- ④ Light: Inner LED lights
 ※In order to change the light, separate lens cover and light cover.
- ⑤ Bracket mounting hole on back side:
 Install the vision master from the back side using bracket B.
- ⑥ Power I/O connector: Connect the power I/O cable.
- ⑦ Ethernet connector: Connect the Ethernet cable. It is for TCP/IP communication.
- ⑧ Focus adjuster: After fixing vision sensor, adjust focus by rotating the focus adjuster.
- ⑨ Indicators

Indicator		Color	Descriptions
POWER	Power indicator	Green LED	Turns ON when power is supplied.
LINK	Ethernet connection indicator	Green LED	Turns ON when vision sensor is connected with PC (Ethernet communication).
DATA	Data transmission indicator	Orange LED	Flashes when data is transmitted from vision sensor to PC.
FAIL	Failure indicator	Red LED	Flashes when detects failure during work group inspection.
PASS	Pass indicator	Green LED	Flashes when passed inspection during work group inspection.

2 Specifications

Model		VG-M04□-8E	VG-M04□-16E	VG-M04□-25E	VG-C04□-8E	VG-C04□-16E	VG-C04□-25E
Effective focal length		8mm	16mm	25mm	8mm	16mm	25mm
Min. working distance		50mm	100mm	200mm	50mm	100mm	200mm
Power supply		24VDC \equiv ($\pm 10\%$)					
Power consumption		1A					
Inspection	Inspection item	Alignment, brightness, contrast, area, edge, shape comparison, length, angle, diameter, object counting			Alignment, brightness \times^2 , contrast \times^2 , area \times^2 , edge, shape comparison \times^2 , length, angle, diameter, object counting \times^2 , color identification, area of color, object of color counting		
	Work group	32					
	Simultaneous inspection	64					
	Camera frame per second \times^1	Max. 60fps					
Image snap	Image filter	Preprocessing, external filter (color filter, polarizing filter)					
	Image element	1/3 inch mono CMOS			1/3 inch color CMOS		
	Resolution	752×480 pixel					
	Camera frame per second \times^1	Max. 60fps					
	Shutter	Global shutter					
	Exposure time	20 to 10,000 μ s					
Light	ON/OFF method	Pulse					
	Color	White, red, green, blue					
Trigger mode		External trigger, internal trigger, free-run trigger					
Input	Signal	Rated input 24VDC \equiv ($\pm 10\%$)					
	Type	External trigger input (TRIG), encoder input (IN2, IN3), work group change (IN0 to IN3)					
Output	Signal	NPN or PNP open collector output Max. 24VDC \equiv 50mA, residual voltage: max. 1.2VDC \equiv					
	Type	Control output (OUT0 to OUT3) : inspection completion, inspection result, external light trigger, alarm, camera busy					
	FTP transmission	Possible					
Communication		Ethernet(TCP/IP), 100BASE-TX/10BASE-T					
Protection circuit		Output short over current protection circuit					
Indicator		<ul style="list-style-type: none"> Power indicator (POWER), Ethernet connection indicator (LINK), 					

Model		VG-M04□-8E	VG-M04□-16E	VG-M04□-25E	VG-C04□-8E	VG-C04□-16E	VG-C04□-25E
		pass indicator (PASS): green LED · Data transmission indicator (DATA): orange LED · Failure indicator (FAIL): red LED					
Insulation resistance		Over 20MΩ (at 500VDC megger)					
Dielectric strength		500VAC 50/60Hz for 1 min					
Vibration		1.5mm amplitude at frequency of 10 to 55Hz (for 1 min) in each X, Y, Z direction for 2 hours					
Shock		300m/s ² (approx. 30G) in each X, Y, Z direction for 3 times					
Environment ^{※3}	Ambient temp.	0 to 45°C, storage: -20 to 70°C					
	Ambient humi.	35 to 85%RH, storage: 35 to 85%RH					
Protection structure		IP67 (IEC standard)					
Material		Case: aluminum, lens cover/focus adjuster: polycarbonate, cable: polyurethane					
Accessories		Assembly tool, bracket A, mounting screw: 2					
Sold separately		Light, color filter, polarizing filter, power I/O cable, Ethernet cable, bracket B, protection cover					
Approval		CE, 					
Weight ^{※4}		Approx. 415g (approx. 273g)	Approx. 416g (approx. 274g)	Approx. 416g (approx. 274g)	Approx. 415g (approx. 273g)	Approx. 416g (approx. 274g)	Approx. 416g (approx. 274g)

※1. The number of camera frames per second can be different by image setting or inspection item.

※2. These inspections identify data by converting the color image to the mono image.

※3. Environment resistance is rated at no freezing or condensation.

※4. The weight includes packaging. The weight in parenthesis is for unit only.

3 Dimensions

3.1 Body

(unit: mm)

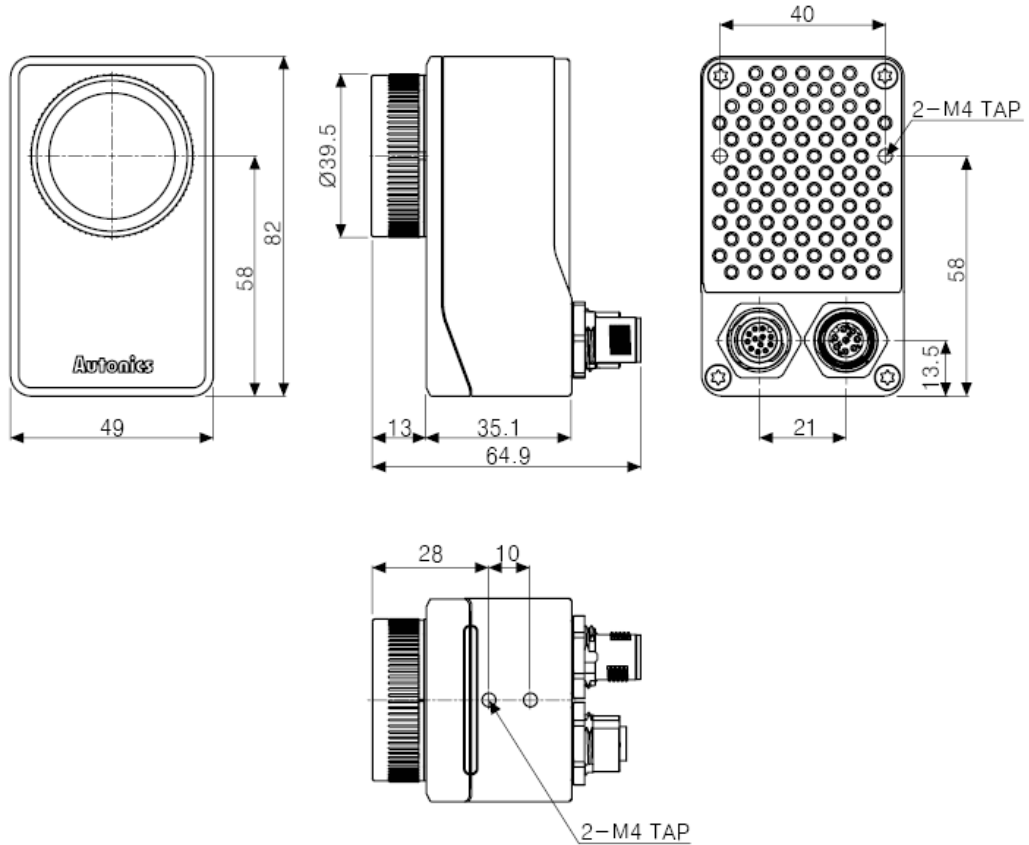

3.2 Bracket

3.2.1 Bracket A (BK-VG-A)

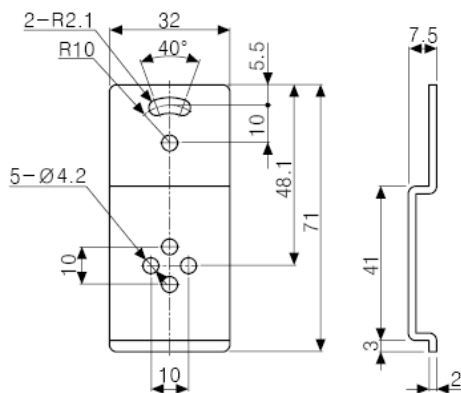

3.2.2 Bracket B (BK-VG-B)

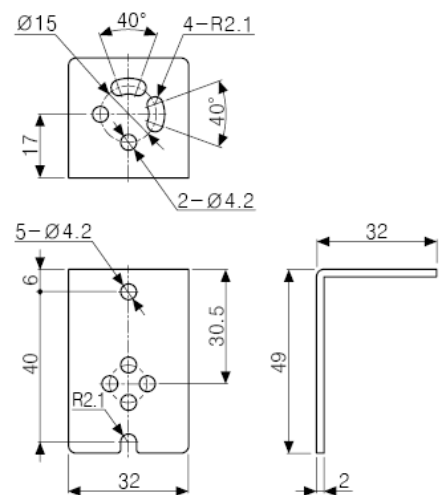

3.3 Cable

(unit: mm)

3.3.1 Power I/O cable

(1) CID Series

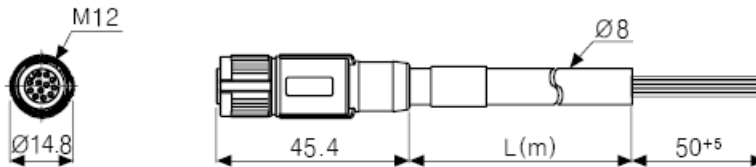

(2) CLD Series

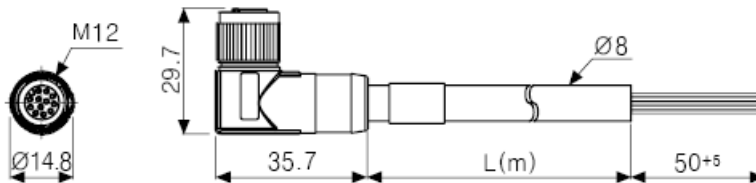

※L(m): 2m, 5m, 10m
Please refer to the cable length.

3.3.2 Ethernet cable

(1) CIR Series

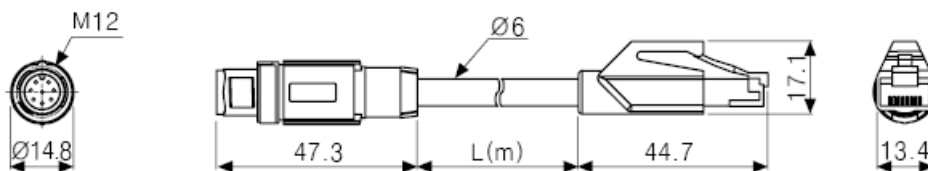

(2) CLR Series

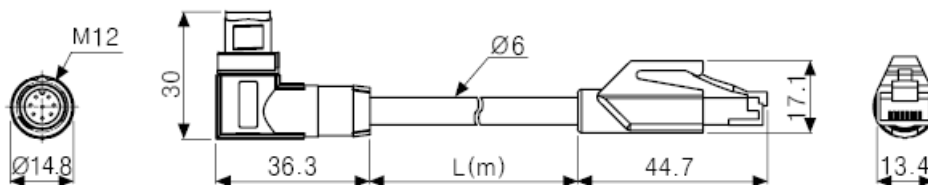

※ L(m): 2m, 5m, 10m
Please refer to the cable length.

4 Connections

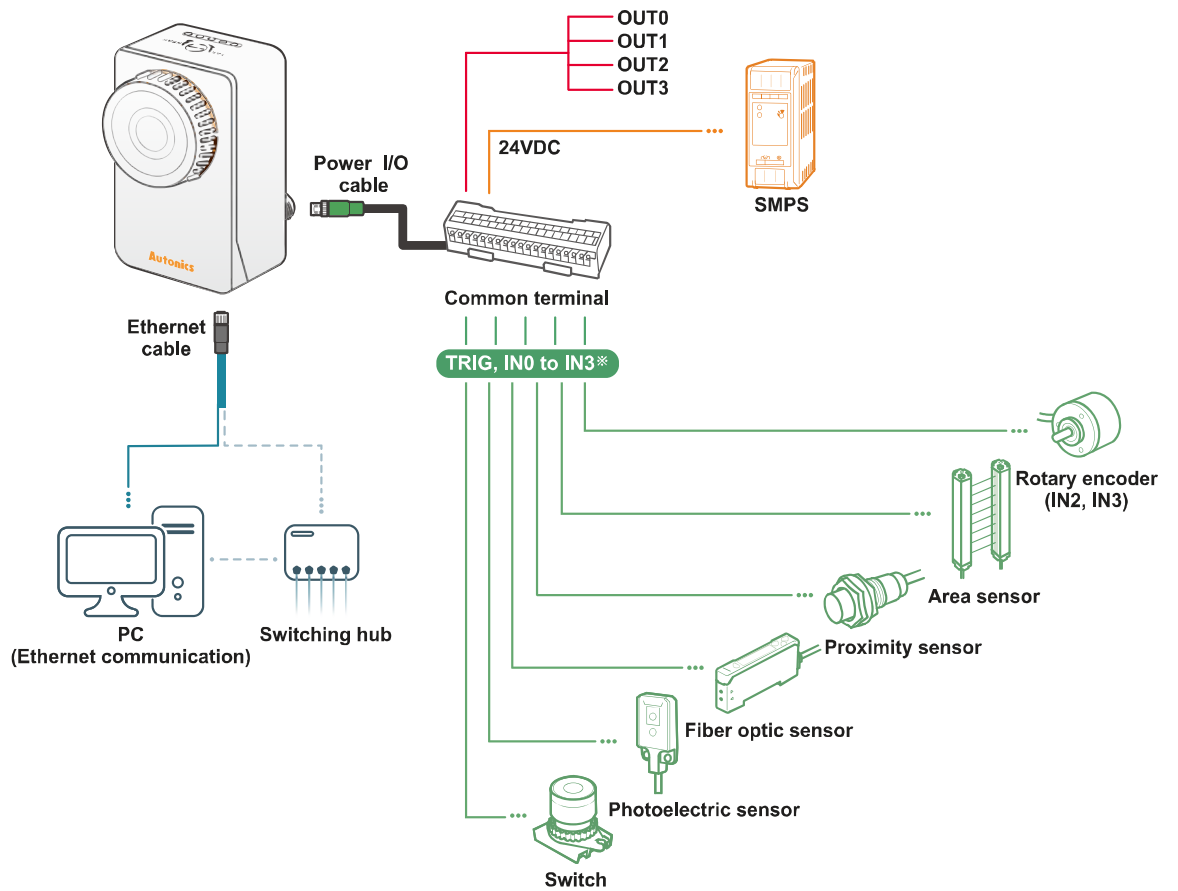

※ Use the product which of power supply is 24VDC.
 When selecting a product, please refer to Autonics selection guide.

4.1 Power I/O Cable (M12 12-pin connector)

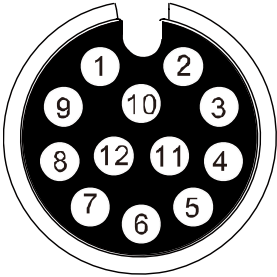
Pin arrangement	Pin No.	Cable color	Signal	Function	
	1	Brown	24VDC	24VDC	
	2	Blue	GND	GND	
	3	White	TRIG	Trigger input	
	4	Green	IN0	Work group change Bit 0	Work group change - Clock
	5	Pink	IN1	Work group change Bit 1	Work group change - Data
	6	Yellow	IN2	Work group change Bit 2	Encoder - Up counter - Quadrature A
	8	Gray	IN3	Work group change Bit 3	Encoder - Down counter - Quadrature B
	11	Gray/Pink	COMMON	COMMON	
	7	Black	OUT0	Inspection completion, inspection result, external light trigger, alarm, camera busy	
	9	Red	OUT1		
	10	Purple	OUT2		
	12	Red/Blue	OUT3		

4.1.1 Input

(1) External trigger input (TRIG), Work group change input (IN0 to IN3)

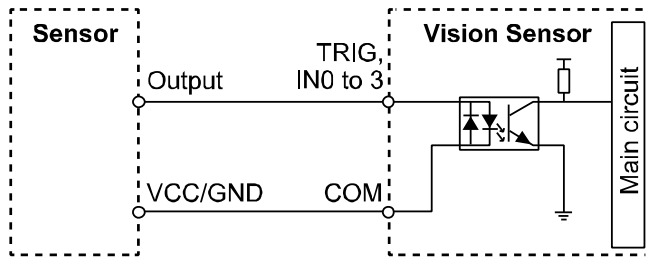

(2) Encoder input (IN2, IN3)

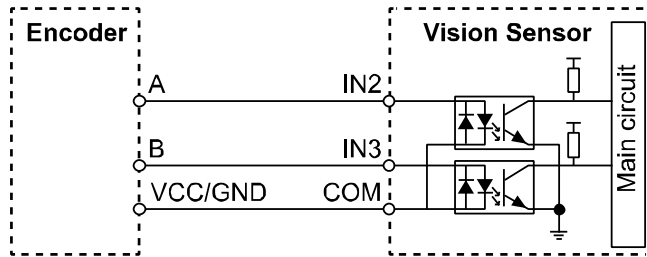

4.1.2 Output (OUT0 to OUT3)

(1) NPN open collector output

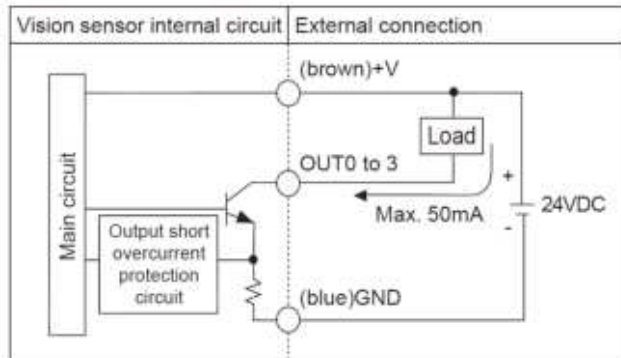

(2) PNP open collector output

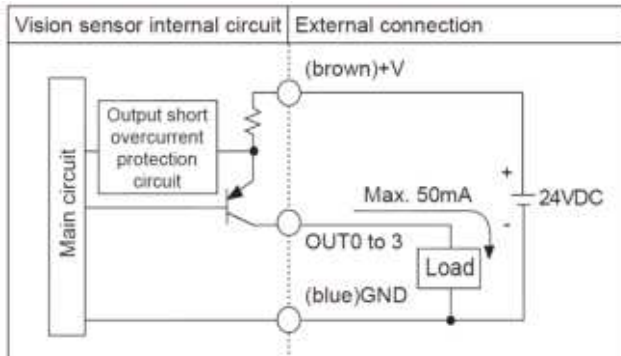

4.2 Ethernet Cable (M12 8-pin/RJ45 connector)

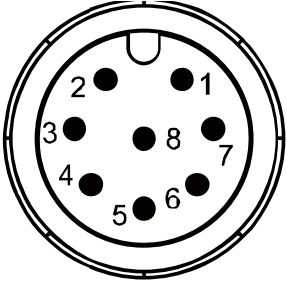
Pin arrangement	M12 8-pin		Cable color	RJ45	
	Pin No.	Signal		Pin No.	Signal
	6	RX+	White/Orange	1	TX+
	4	RX-	Orange	2	TX-
	5	TX+	White/Green	3	RX+
	8	TX-	Green	6	RX-
	1	-	White/Blue	5	-
	7	-	Blue	4	-
	2	-	White/Brown	7	-
	3	-	Brown	8	-

5 Installation

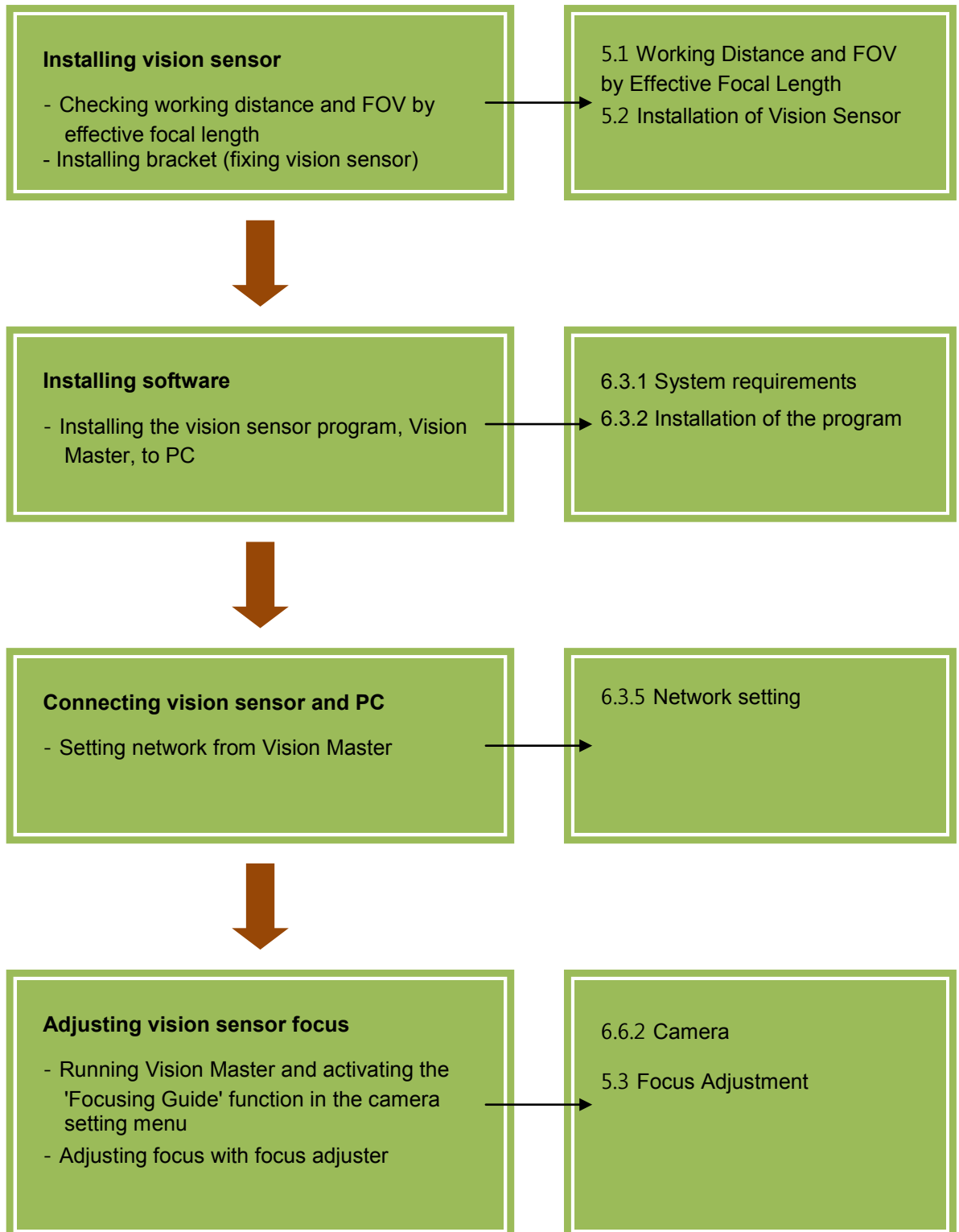

5.1 Working Distance and FOV by Effective Focal Length

Please check working distance by effective focal length and FOV (Field of View).

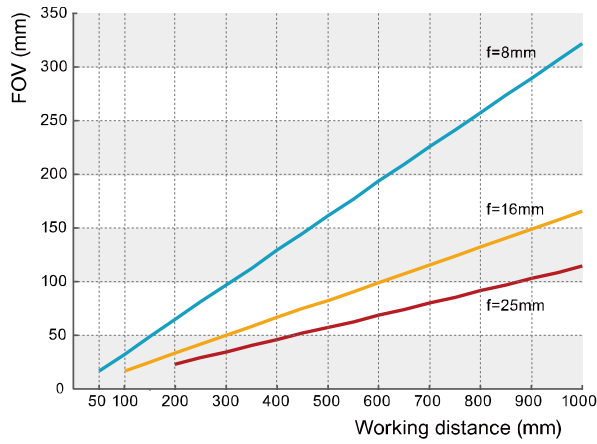

Effective focal length(f)	8mm	16mm	25mm
Min. working distance	50mm	100mm	200mm
Brightness	F2.0	F2.5	F2.5

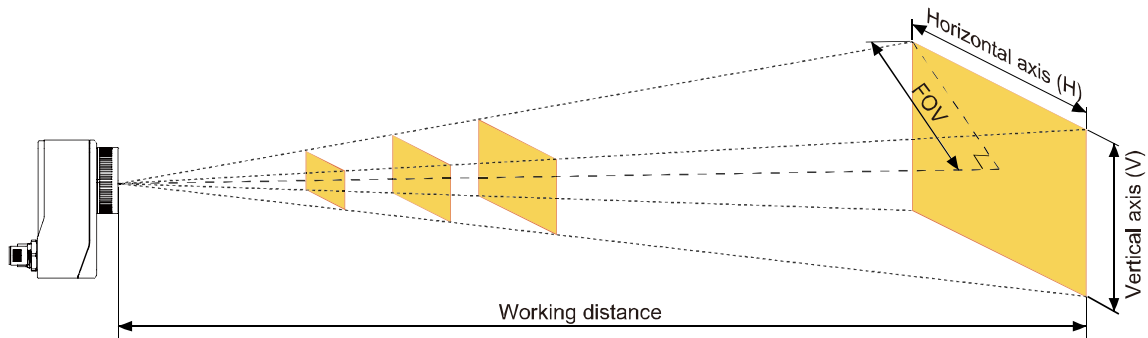

※Sensing range by effective focal length (unit: mm)

Effective focal length	Working distance	50	100	200	300	400	500	600	700	800	900	1,000
8mm	FOV	16	32	64	96	129	161	193	255	257	289	322
	Horizontal axis (H)	27	54	108	163	217	271	325	380	434	488	542
	Vertical axis (V)	17	35	69	104	138	173	208	242	277	311	346
16mm	FOV	—	16	33	49	66	82	99	155	132	148	165
	Horizontal axis (H)	—	28	56	83	111	139	167	195	222	250	278
	Vertical axis (V)	—	18	35	53	71	89	106	124	142	160	177
25mm	FOV	—	—	23	34	46	57	68	80	91	103	114
	Horizontal axis (H)	—	—	38	58	77	96	115	134	154	173	192
	Vertical axis (V)	—	—	25	37	49	61	74	86	98	110	123

5.2 Installation of Vision Sensor

1st Fix vision sensor using bracket.

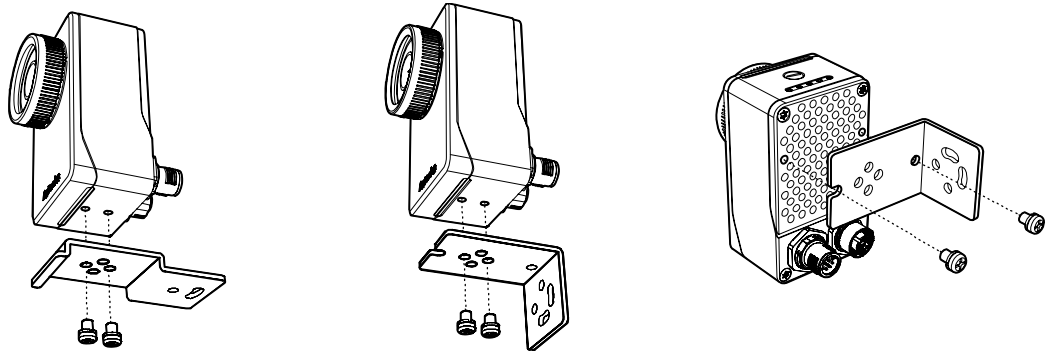

<Install horizontally from the bottom>
-bracket A

<Install vertically from the bottom>
-bracket B

<Install vertically from the back side>
-bracket B

2nd Place the sensing target at the center of the vision sensor lens.

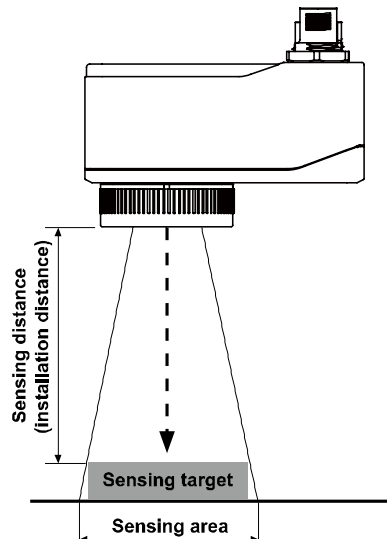

5.3 Focus Adjustment

After installing and running Vision Master, use the focusing guide function to adjust the focus. Using (-) screwdriver, turn focus adjuster to right and left to adjust the focus.

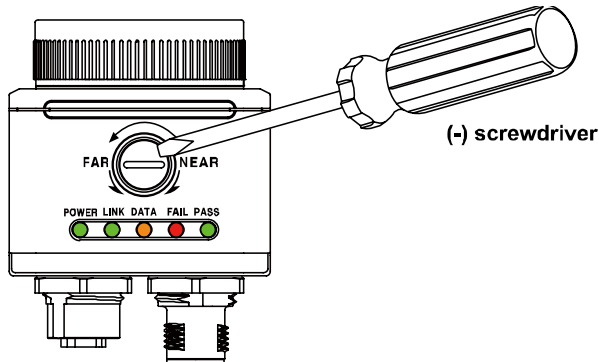

※Please refer to '6.3 Installation of Vision Master' for the installation of Vision Master and network setting.

※Please refer to '6.6.2 Camera (6) Focusing guide ' for the focusing guide.

5.4 Replacement of Light and Filter

5.4.1 Replacement of color filter or polarizing filter

1st Put and fix the assembly tool into the groove on the side of the vision sensor.

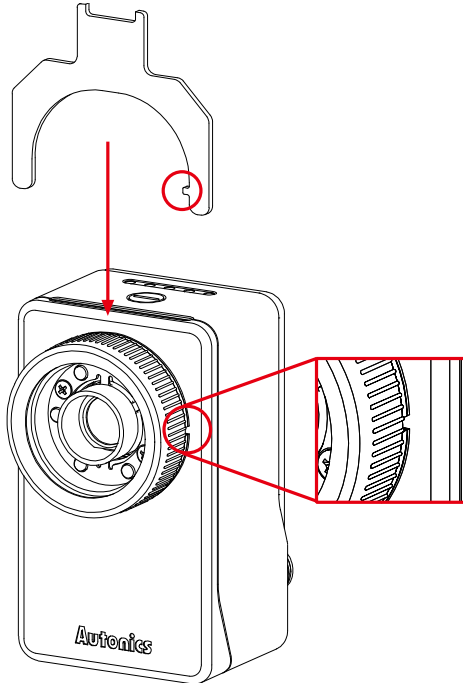

2nd While fixing the vision sensor with the assembly tool, hold the lens cover and disassemble it in a counter clock wise direction.

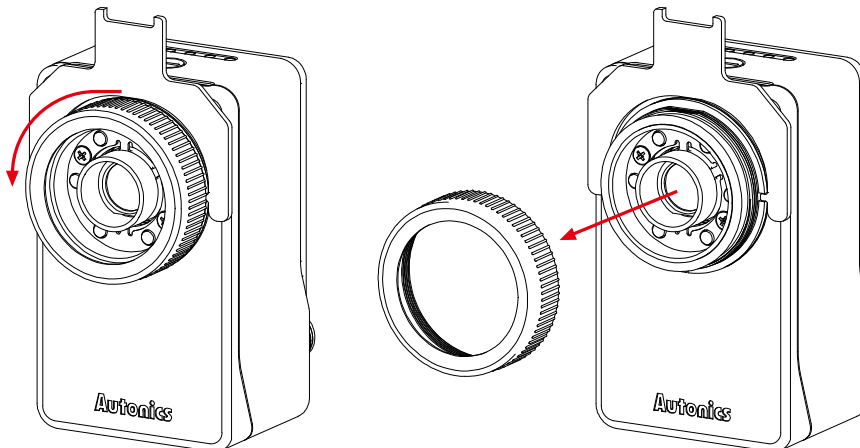

3rd Instead of the disassembled lens cover, assemble another color filter or polarizing filter in clock wise direction.

5.4.2 Replacement of light

- 1st Put and fix the assembly tool into the groove on the side of the vision sensor.
- 2nd While fixing the vision sensor with the assembly tool, hold the lens cover and disassemble it in a counter clock wise direction.
- 3rd Disassemble the light cover using the (+) screwdriver, and disassemble the inner LED light.

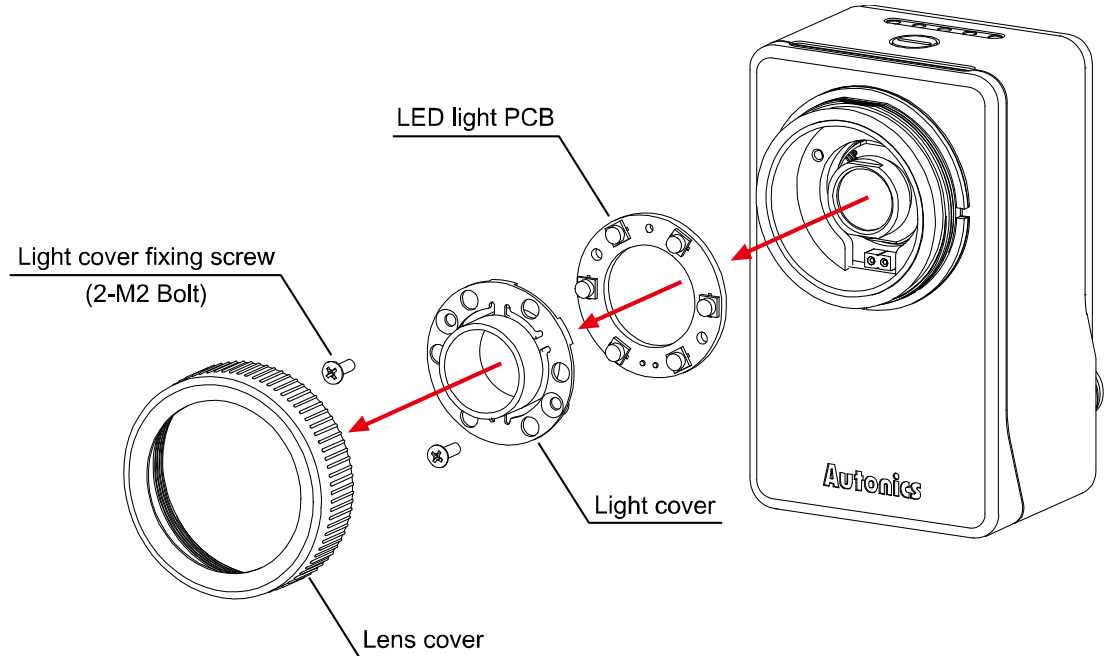

- 4th Place the connection pin of PCB of the inner LED light to face the direction of 6 o'clock and assemble it to the vision sensor body.

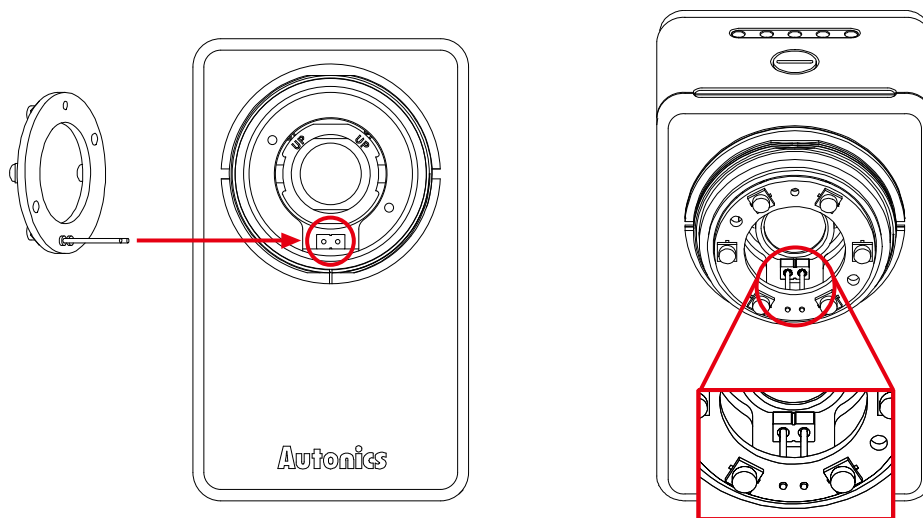

- 5th Align the light cover with the groove in the direction of 12o'clock and fix it with the screw. Tighten them with the 1.2kgf-cm of tightening torque.

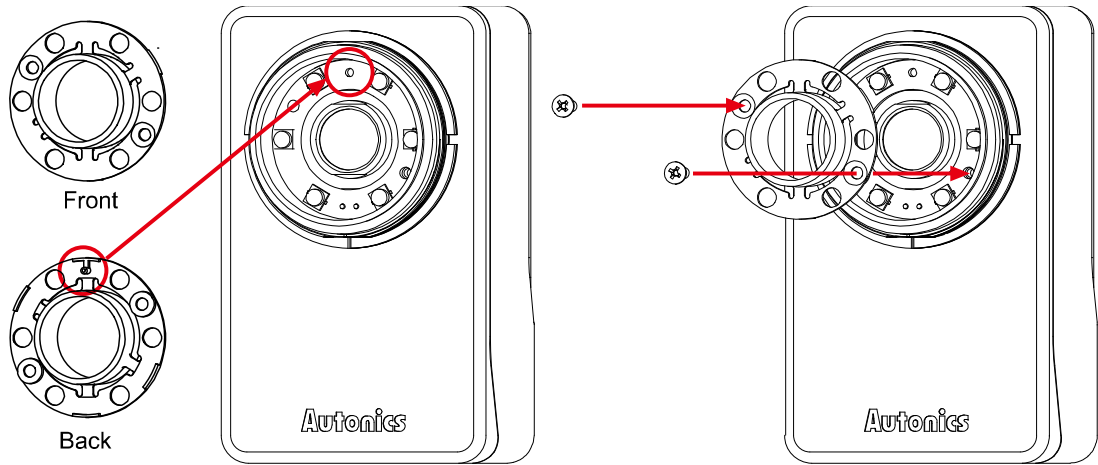

- 6th Assemble the disassembled lens cover in clock wise direction.

6 Vision Sensor Program [Vision Master]









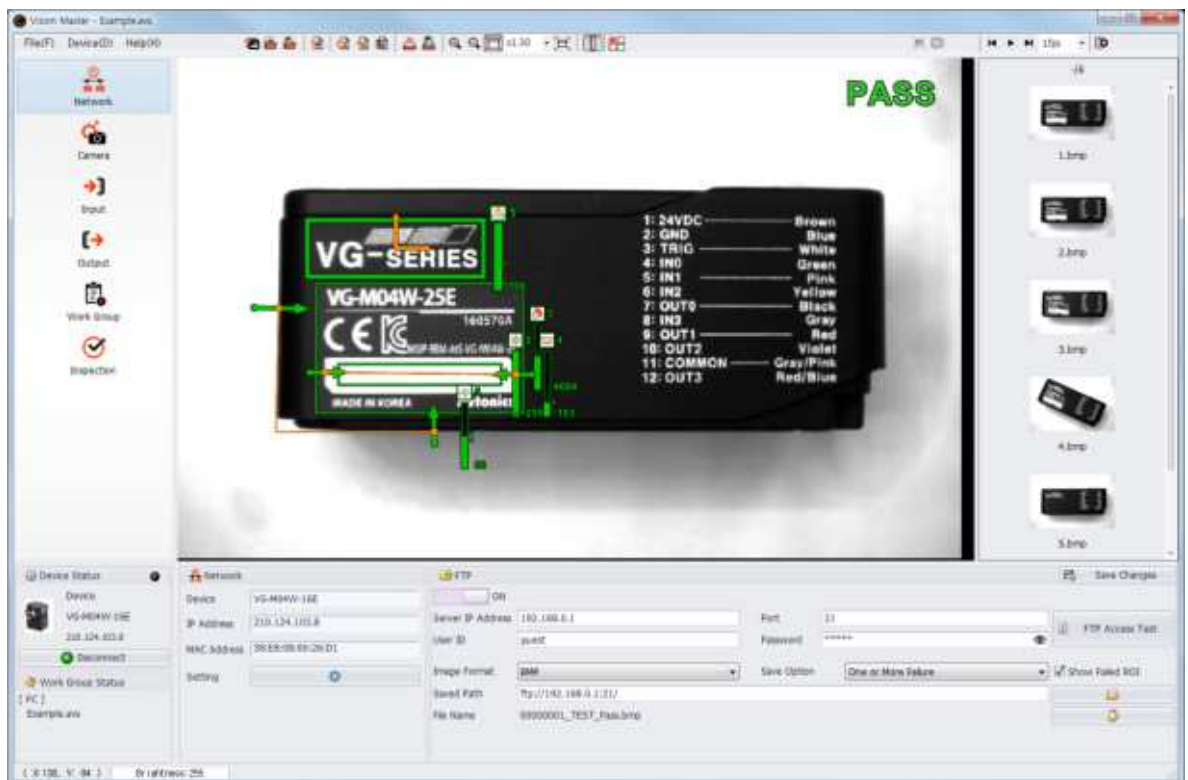





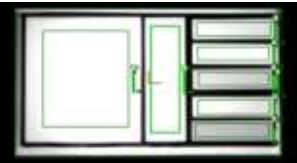
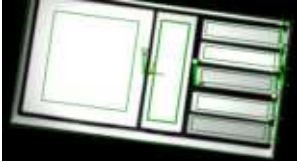
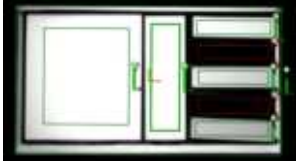

6.1 Overview















Vision Master is the vision sensor program that is connected with VG Series, Autonics vision sensor, to utilize it.



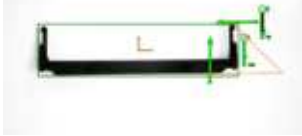

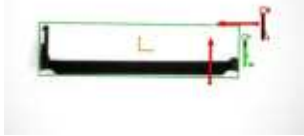

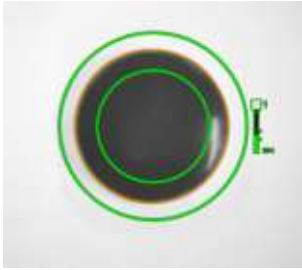
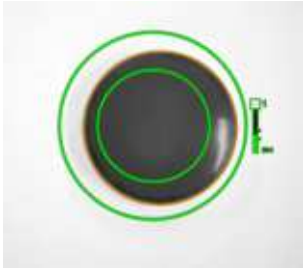



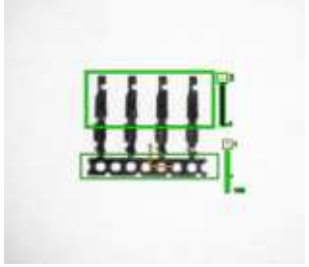
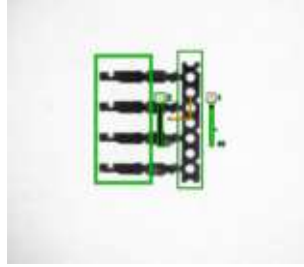
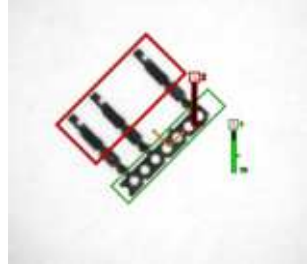

Vision Master provides graphic user interface to make setting parameter and managing monitoring data of vision sensor easy.

It is connected with vision sensor through Ethernet (TCP/IP) and exchange data with vision sensor.

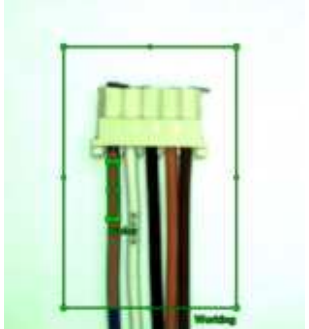

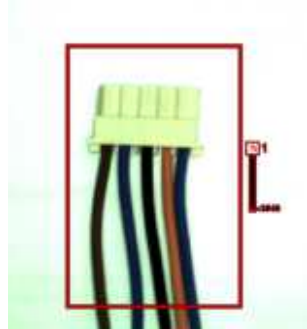
Item	Description		
 Alignment	Compares features of the registered image and input image to search for a similar pattern position, and inspects the input image with information of the searched pattern position and rotation angle.		
	<Template> 	<Pass> 	<Fail> 
 Brightness	Inspects brightness of the ROI in the input image based on the mean brightness value of the ROI (Region of Interest) in the registered image.		
	<Template> 	<Pass> 	<Fail> 
 Contrast	Inspects contrast of the ROI in the input image based on contrast of the ROI in the registered image.		
	<Template> 	<Pass> 	<Fail> 
 Area	Inspects the ROI area of the input image based on the ROI area of the image registered by user.		
	<Template> 	<Pass> 	<Fail> 
 Edge	Inspects the direction of the edge in the input image based on the edge registered by user in the same area.		
	<Template> 	<Pass> 	<Fail> 

Item	Description		
 <p>Shape comparison</p>	<p>Compares shape of object in the ROI registered by user and that of the input image.</p>		
	<p><Template></p> 	<p><Pass></p> 	<p><Fail></p> 
 <p>Length</p>	<p>Inspects the input image based on the length between two edges registered by user.</p>		
	<p><Template></p> 	<p><Pass></p> 	<p><Fail></p> 
 <p>Angle</p>	<p>Inspects the input image based on the angle between two edges registered by user.</p>		
	<p><Template></p> 	<p><Pass></p> 	<p><Fail></p> 
 <p>Diameter</p>	<p>Inspects the input image based on the area between two circles registered by user.</p>		
	<p><Template></p> 	<p><Pass></p> 	<p><Fail></p> 

Item	Description		
 <p data-bbox="164 548 354 577">Object counting</p>	<p data-bbox="402 320 1406 376">Compares the number of objects in the ROI which is in the image registered by user and that in the input image.</p>		
	<p data-bbox="402 421 539 450"><Template></p> 	<p data-bbox="746 421 836 450"><Pass></p> 	<p data-bbox="1086 421 1161 450"><Fail></p> 
 <p data-bbox="156 965 368 994">Color identification</p>	<p data-bbox="402 761 1235 790">Compares color of the ROI registered by user and that of the input image.</p>		
	<p data-bbox="402 835 539 864"><Template></p> 	<p data-bbox="746 835 836 864"><Pass></p> 	<p data-bbox="1086 835 1161 864"><Fail></p> 
 <p data-bbox="188 1397 338 1426">Area of color</p>	<p data-bbox="402 1137 1385 1193">Compares the area of a certain color in the ROI registered by user and that in the input image.</p>		
	<p data-bbox="402 1223 539 1252"><Template></p> 	<p data-bbox="746 1223 836 1252"><Pass></p> 	<p data-bbox="1086 1223 1161 1252"><Fail></p> 
 <p data-bbox="177 1805 347 1883">Object of color counting</p>	<p data-bbox="402 1624 1358 1680">Compares the number of objects in a certain color which are in the ROI of registered image and that of the input image.</p>		
	<p data-bbox="402 1715 539 1744"><Template></p> 	<p data-bbox="746 1715 836 1744"><Pass></p> 	<p data-bbox="1086 1715 1161 1744"><Fail></p> 

※Color identification, area of color, and object of color counting are only for VG-C Series.

6.2 Vision Master Work Flow

6.2.1 Setting mode

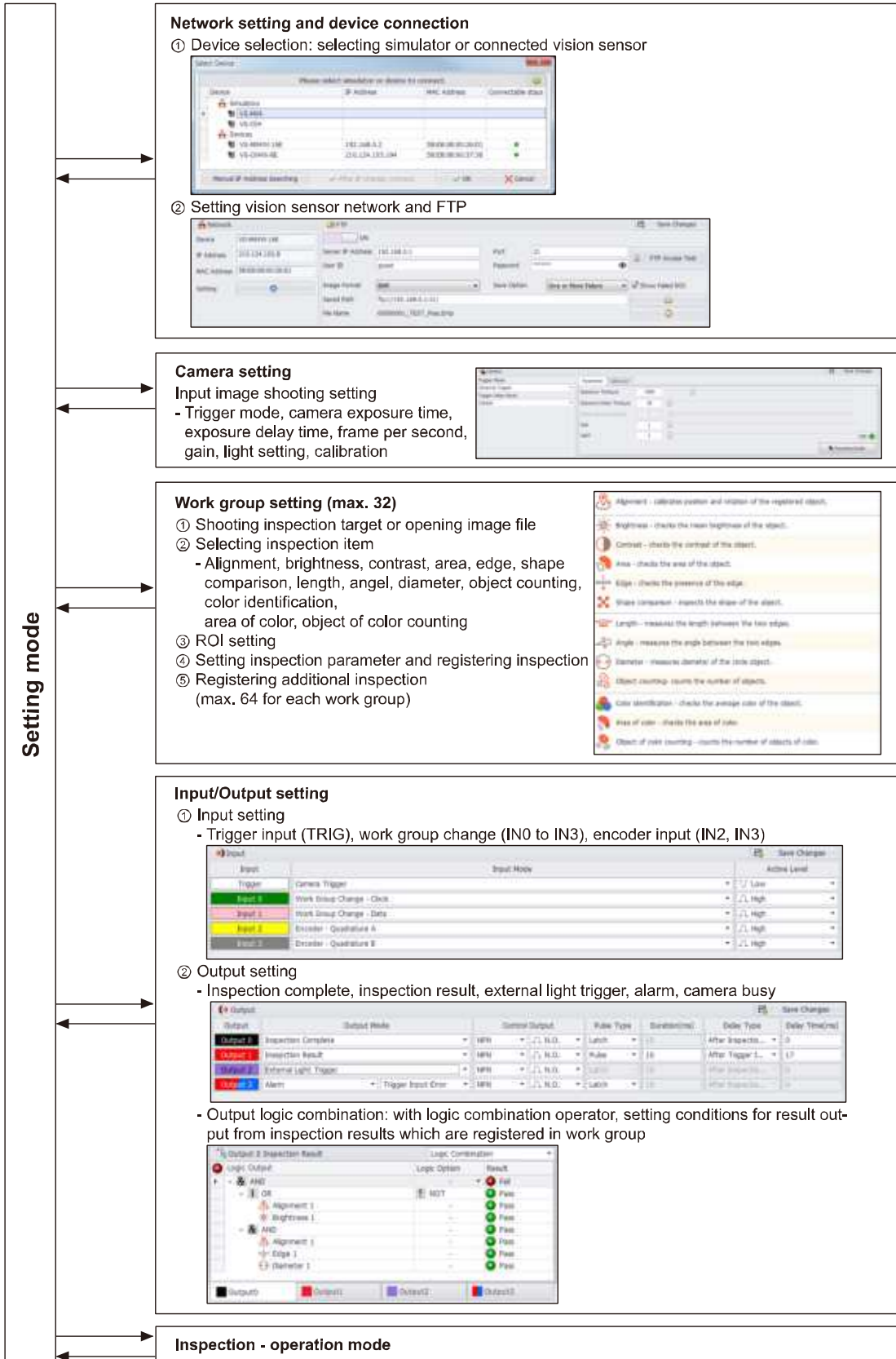

6.2.2 Operation mode

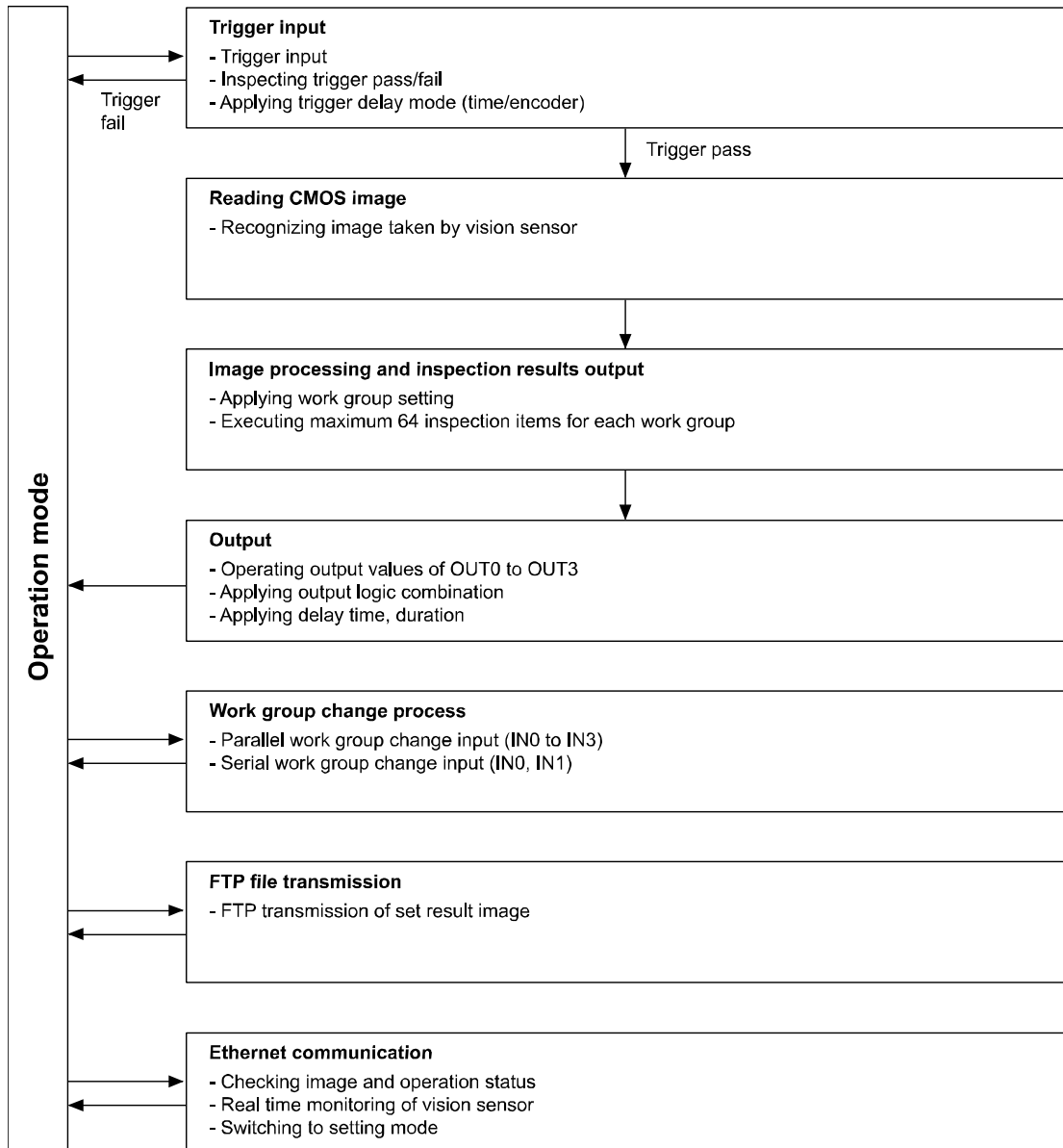

6.3 Installation of Vision Master

6.3.1 System requirements

Item	Minimum specifications
System	32bit (x86) or 64bit (x64) processor over 1GHz
Operations	Microsoft Windows 7/8/10
Memory	1GB+
Hard disk	400MB+ of available hard disk space
VGA	Resolution: 1024x768 or higher
Others	RJ45 Ethernet port

6.3.2 Installation of the program

- 1st Download Vision Master program at Autonics web page(www.autonics.com).
- 2nd Close all programs before you start Vision Master installation.
Double-click Vision Master setup.exe to start installation.
- 3rd When Installer Language window appears, select the language and click [OK] button.



- 4th Click [Next] button in the installation welcome window.

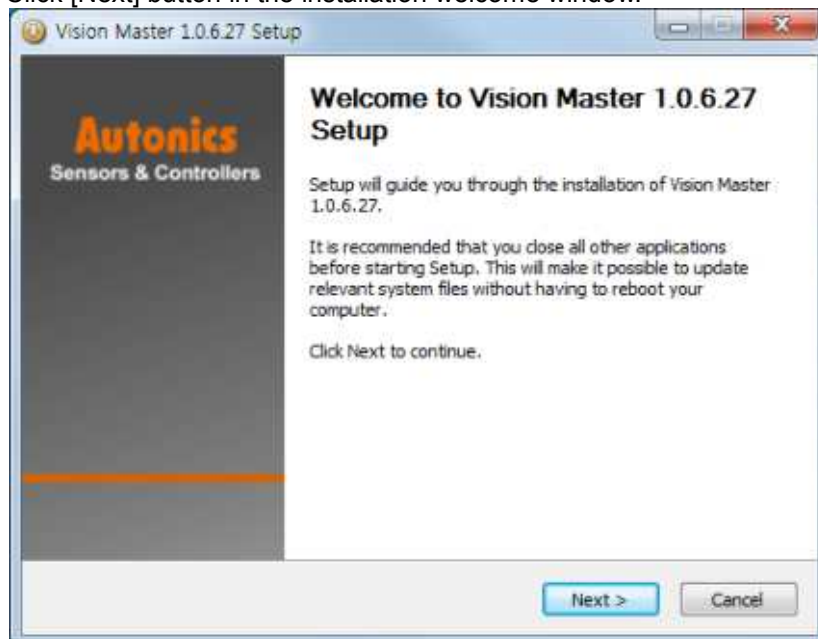

5th This process is license agreement.

You can check whole part of license agreement article by rolling mouse scroll downward, clicking downward arrow or press "Page Down(PgDn)" Key of the keyboard.

Please read the articles thoroughly before click [I Agree] button.

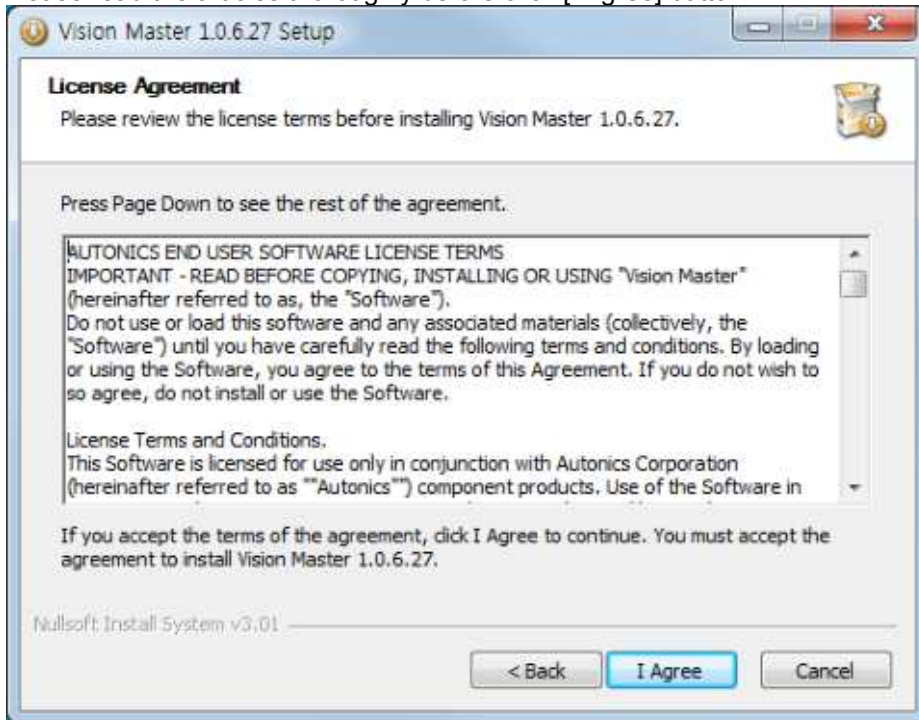

6th Choose Install Location window appears.

Default installation path is as follows.

C:\Program Files (x86)\Autonics\Vision Master\

Click [OK] button to install the program in the default installation path.

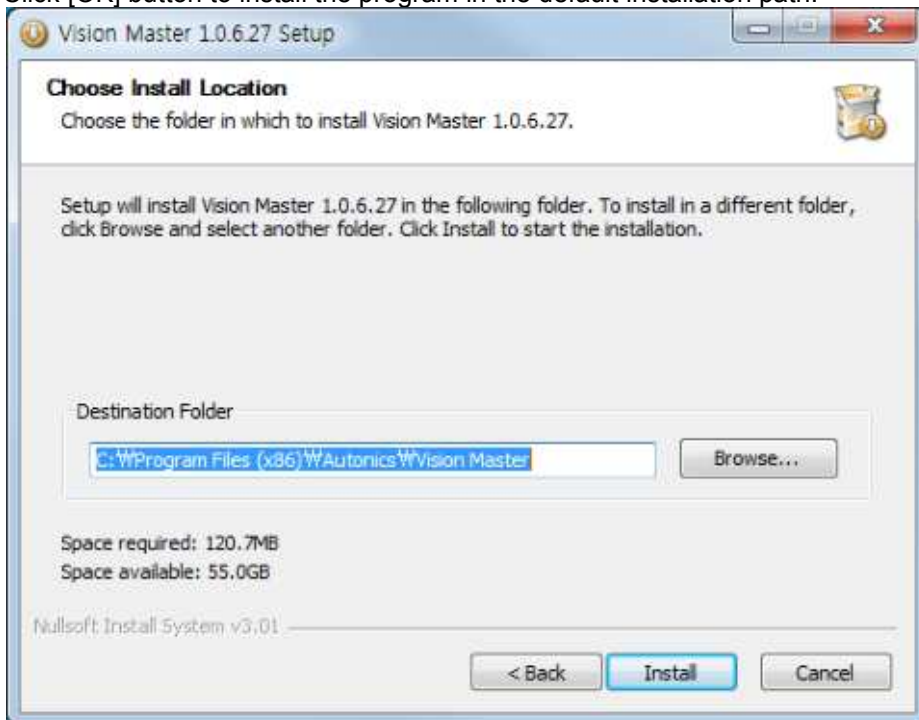

- 7th Click [Install] button to install the program in the default installation path.
If you want to install the program in another installation path, click [Browse..] button to designate a folder you want to install in and click [OK] button.

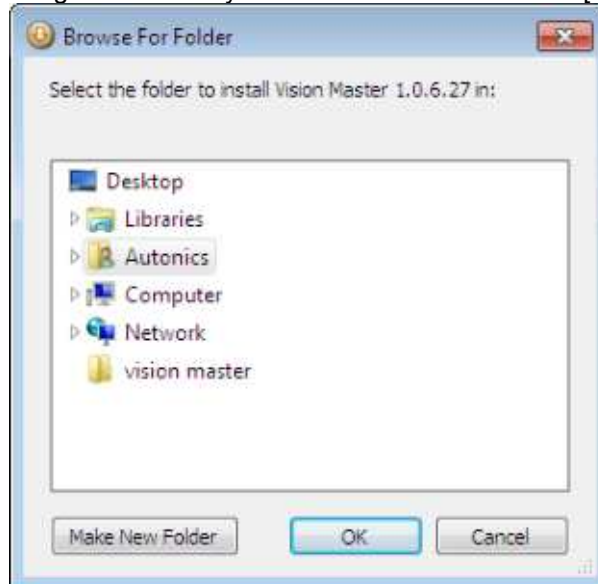

- 8th Installation progress is displayed in the status window as follows.

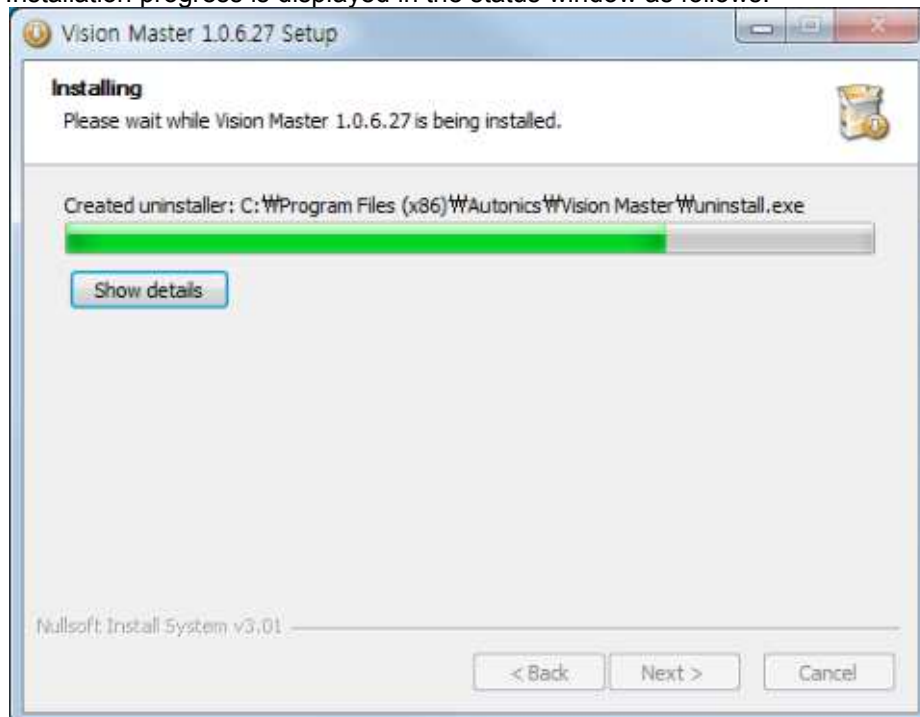

- 9th Installation Complete window appears after installation is completed.
 If the check box in the Installation Complete window is checked, Vision Master runs upon completion of installation.
 You can run Vision Master by double-clicking the Vision Master icon on the desktop.

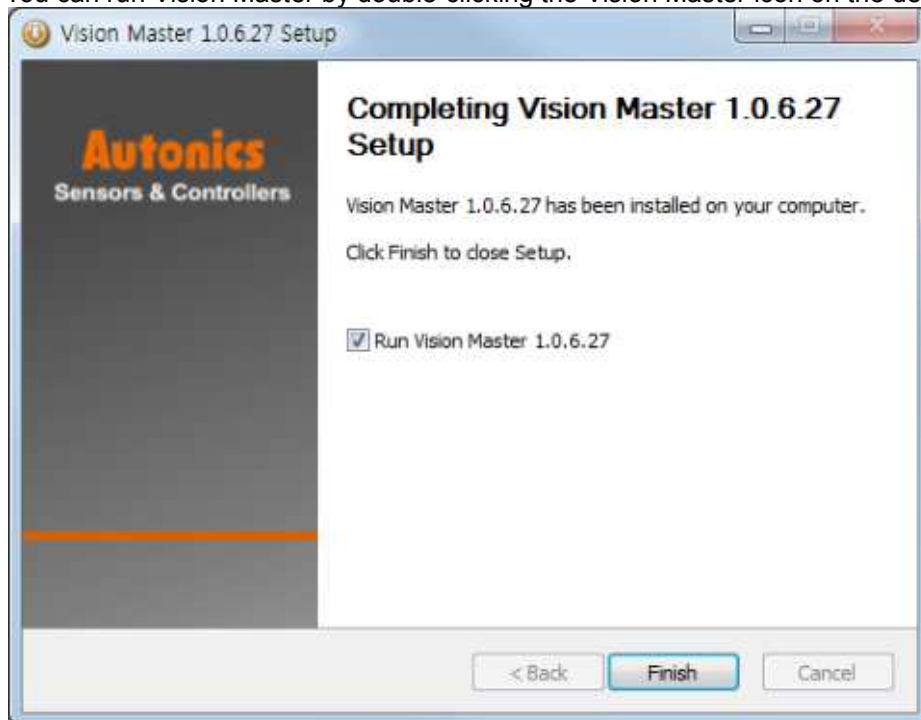

The initial screen displays as follows.

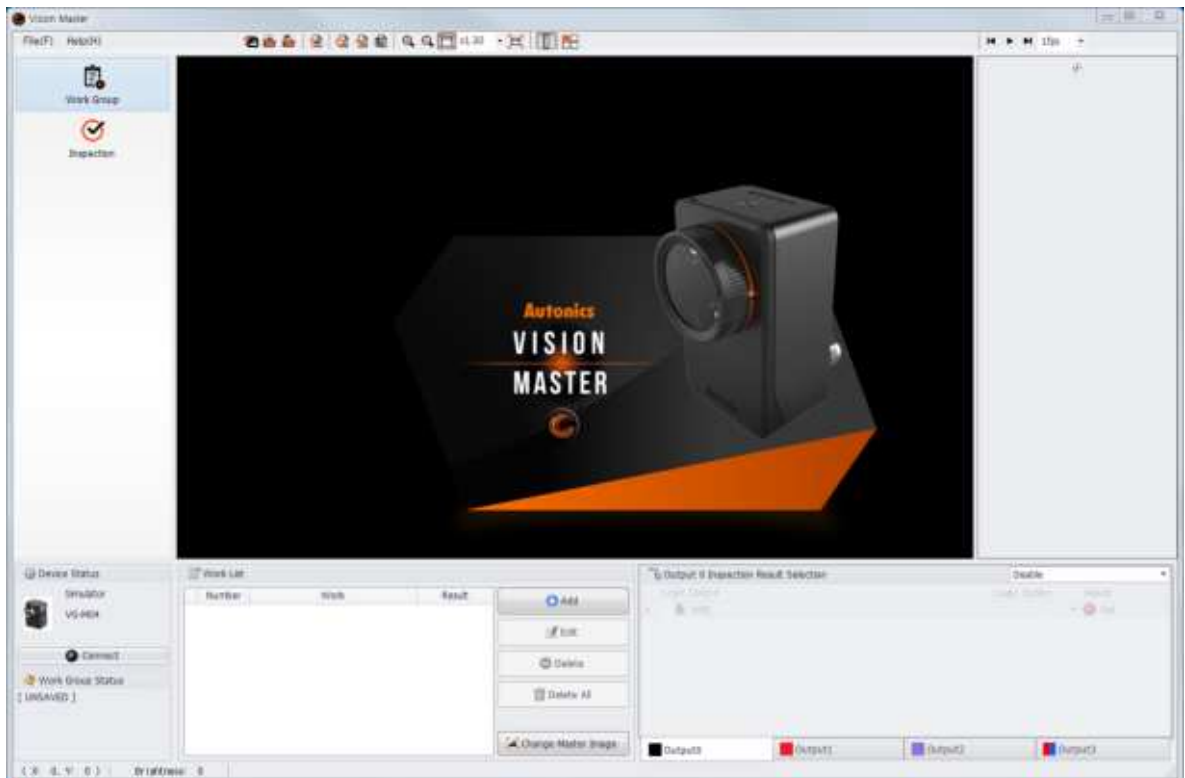

6.3.3 Installation folder structure

This section explains the folder structure created when you installed Vision Master.

The Vision Master folder is created in [C:\Program Files (x86)\Autonics\] as a subfolder unless you select a new destination to change location of Vision Master folder.

After Vision Master is installed completely, Vision Master installation folder and related folders are created as follows in [C:\Users\\Documents\Autonics\] as subfolders and work groups and documents are saved in. The program and all relevant documents are stored in these folders.

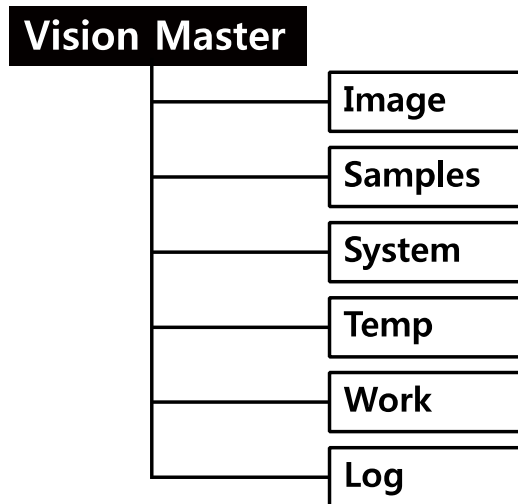

(1) Image folder

If Save Result Image inspection parameter of Vision Master is set to ON, inspection result images are saved in the designated location. Saving location is fixed, so that is cannot be changed by user.

Inspection result images are saved in [C:\Users\\Documents\Autonics\Vision Master\Image\ResultImage].

(2) Sample folder

This folder contains work groups for samples. Load sample files from this folder to Vision Master to test inspection.

(3) Work folder

When saving work groups from Vision Master to PC, the work groups are saved in this folder. When copying work groups from a device to PC using work group manager, the work groups are saved in this folder.

If the saving location is changed when saving work groups in PC, work groups are saved in the changed folder.

(4) Log folder

Log files of connection/disconnection with a device or inspection result are saved.

6.3.4 Removal of the program

There are procedures to uninstall Vision Master, Start > Program > Vision Master > Uninstall or Start > Setting > Control Panel > Add/Remove a Program > Vision Master.

When a confirmation window appears after selecting Remove, click [Yes] button to remove Vision Master from the computer.

6.3.5 Network setting

Change the network settings in Vision Master to connect with a device (vision sensor).

When executing Vision Master, Select Device window appears. Simulator or connected devices are displayed in the window. You can check connectable devices and connected devices using Refresh icon () on the top of the window.

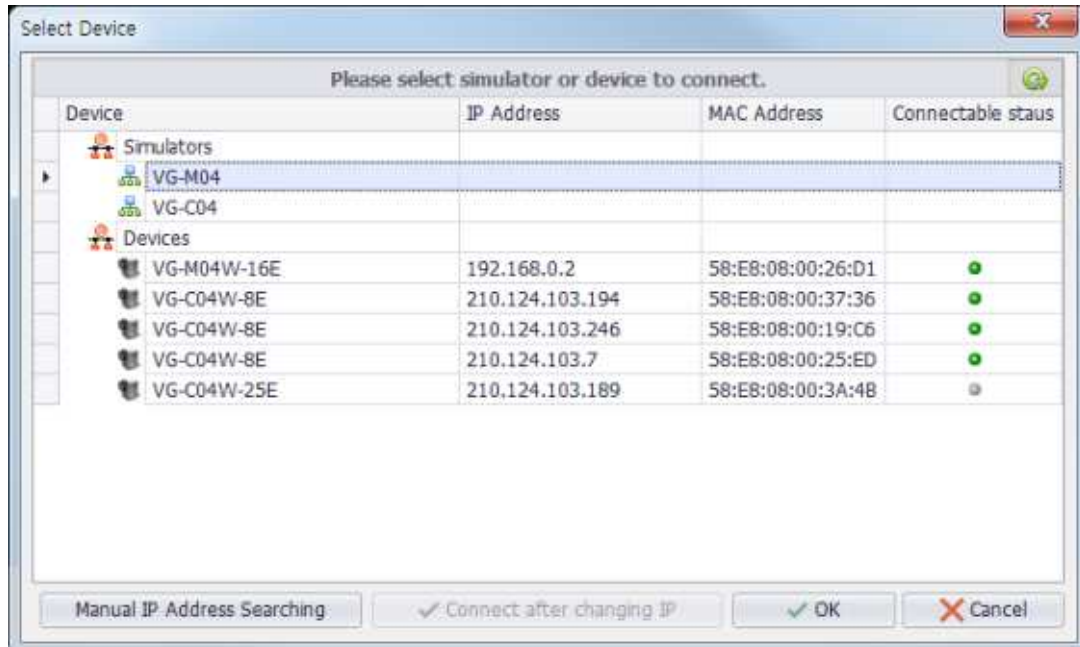

Factory default of the device (vision sensor) is as follows.

IP address	192.168.0.2
Subnet mask	255.255.255.0
Gateway	192.168.0.1

**Note**

A list of the currently connected vision sensor is displayed. After checking “connectable status” indicator, and connect a vision sensor.

● : Connectable

○ : Unconnectable

- The vision sensor is not connectable because it is connected to another PC already.

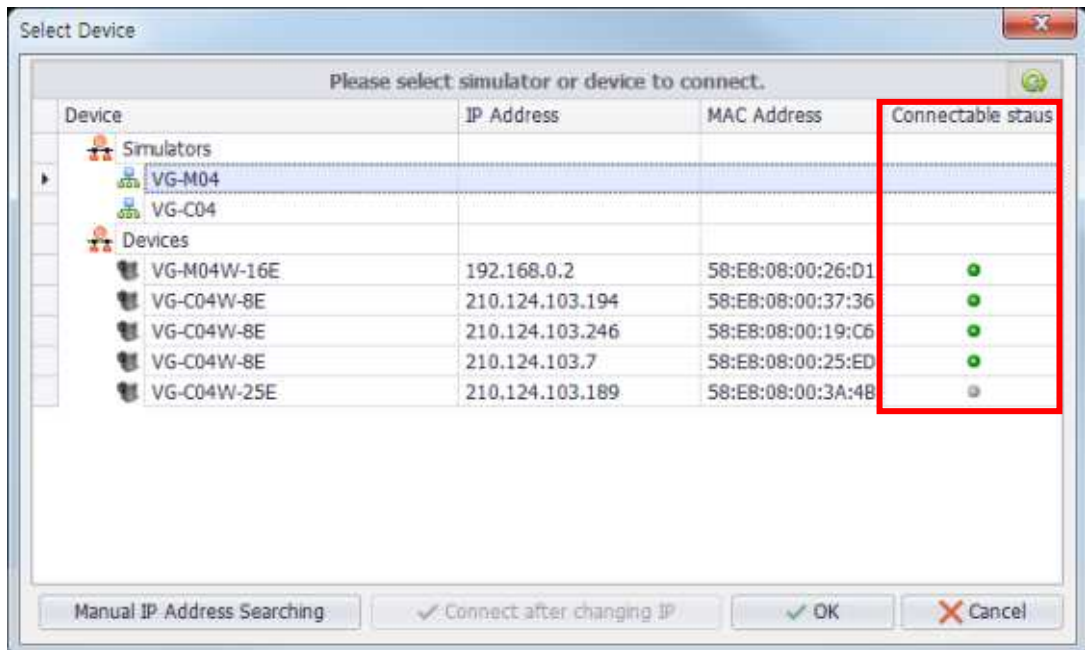

(1) Change of device IP address

You can change IP address of the device to connect.

1st Select the device to connect, and click "After IP change, connect" button.

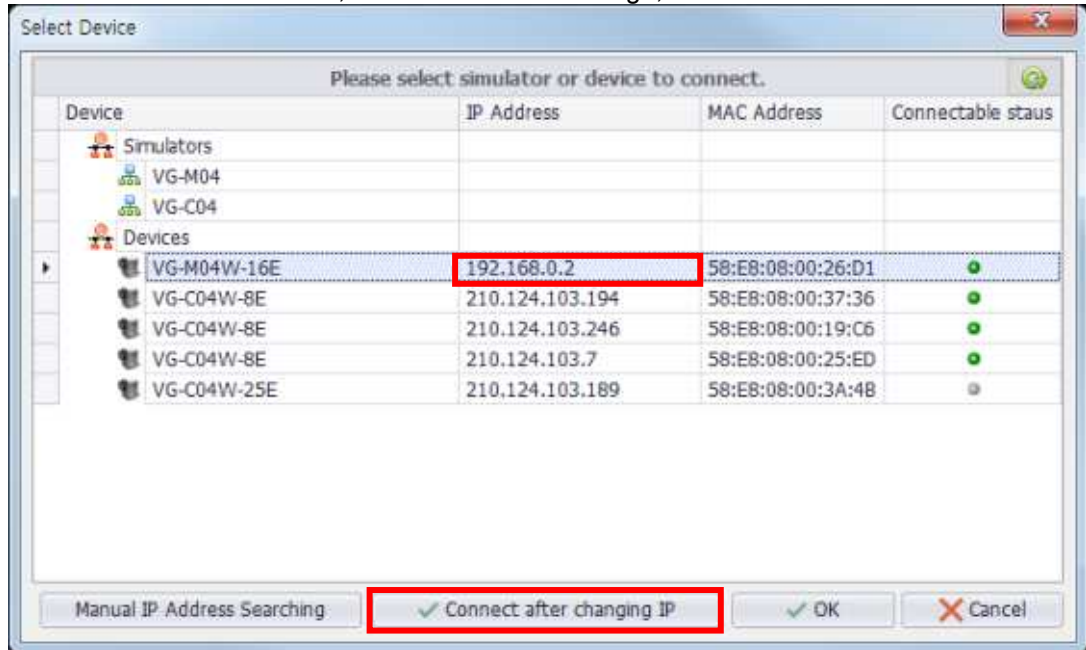

2nd Change IP address in Change Network Setting window.

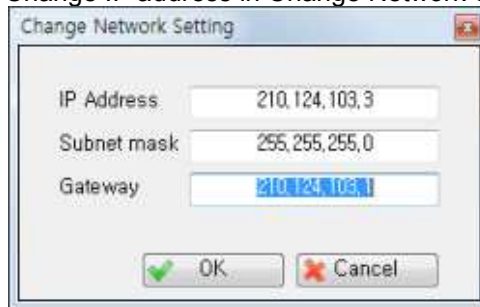
**Caution**

If changed IP address is same with another IP address which is used in another PC of device, network error can occurs due to IP address conflicts.

(2) Manual search of IP address

If a device is not recognized while it is connected, click "Manual IP Address Searching" and search IP address of the device to connect.

(This is usable only when Gateway of the device and PC are same.)

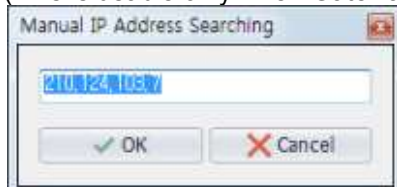

6.4 Start and Exit

6.4.1 Start

Double-click Vision Master icon in the desktop or select Start > Program > Vision Master to start the program.

6.4.2 Exit

Click [X] button on the top right corner of the screen or 'exit' in the file menu to end the program.

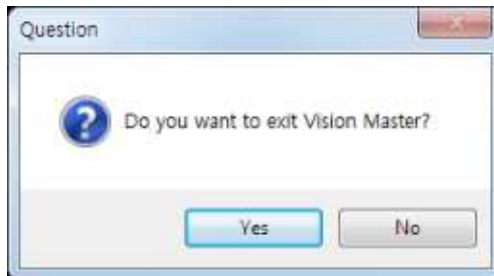

Since work group, parameter settings, and data are not saved automatically, please make sure that you have saved the work group before you exit.





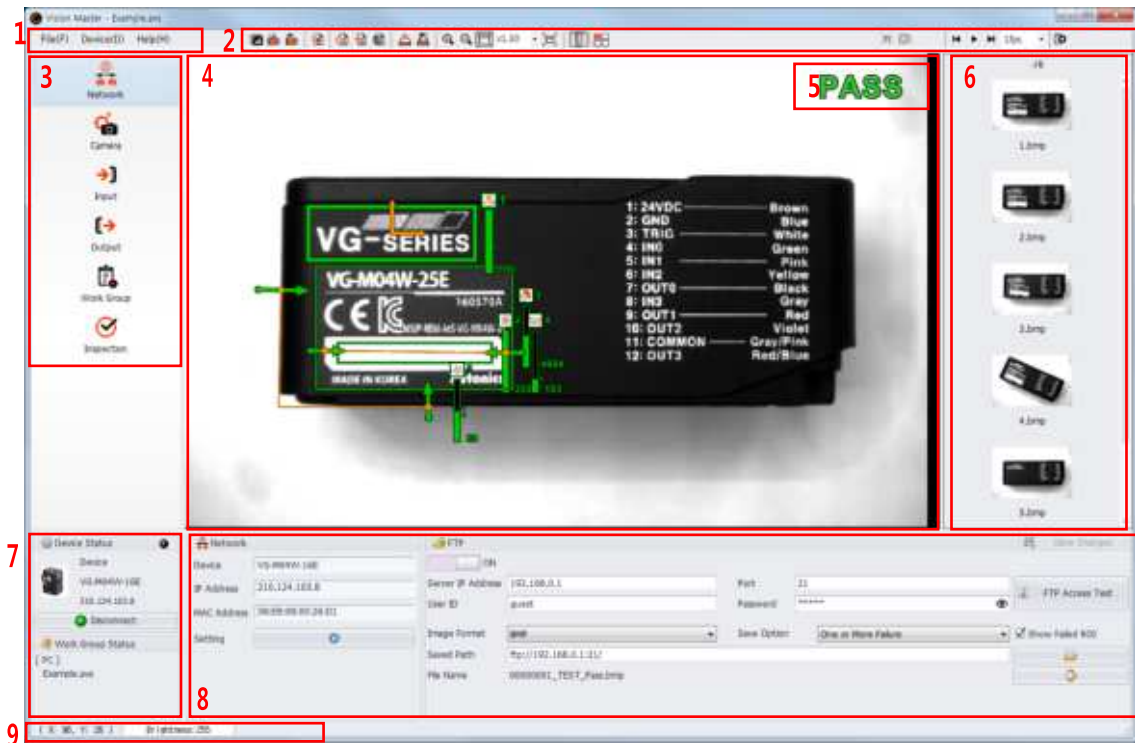

6.5 Vision Master Screen Layout



The program screen is divided into sections as shown in the preceding screenshot and each section is composed of the following items.

No.	Item	Description
1	Menu	Displays Vision Master menus by category.
2	Tool bar	Displays icons of frequently used menu, settings of image window, camera snap, or etc.
3	Setting menu	Displays vision sensor setting parameter menu. If none of device of connected, it is available to connect simulator to register work group and inspection test. Activation of the setting menu depends on the type of the connected device (simulator or device) - Simulator connection: work group, inspection - Device (vision sensor) connection: network, camera, input, output, work group, inspection
4	Image window	Displayed image is different according to the mode and settings. - Setting mode: displays a taken image by vision sensor or selected image between master image to register work group and loaded image to preview window. - Operation mode: displays taken images according to the "View Result Image" settings. Please refer to '6.6.6 Inspection'.
5	Inspection result	Displays inspection result (Pass/Fail) of work group.

No.	Item	Description
6	Preview window	<p>Displays loaded images.</p> <p>If the 'Add Taken Image to Preview Window' icon () is activated, preview window displays images taken by the vision sensor, which are different according to the mode and settings.</p> <ul style="list-style-type: none"> - Setting mode: displays all images taken by the vision sensor. - Operation mode: while inspecting, displays taken images according to the 'View Result Image' settings. Please refer to '6.6.6 Inspection'. <p>Right click in the preview window to display setting menu as follows.</p> 
7	Status information	<p>Displays status information of the device and work group.</p> <ul style="list-style-type: none"> - Device status : displays information of simulator or device (vision sensor) connected to Vision Master. It is available to connect or disconnect device. Indicator on the top right side enables to check the communication status between Vision Master and the device, when the device is connected. The indicator flashes while data communication.  <ul style="list-style-type: none"> - Work group status: displays status of currently registered work group. 
8	Parameter	Displays specific parameters in the setting menu.
9	Image information	Displays brightness value and pixel coordinate of the point where the mouse cursor is pointing on the image window.

6.5.1 Menu

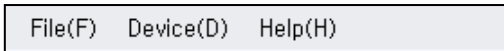

(1) File



- Open Image: Opens the image to inspect.
- Open All Images from Folder: Opens the folder of images to inspect.
- Save Image: Saves the image displayed in Image window.
- Work Group Manager: Displays a list of work group saved in the PC or device to copy, delete, or save. It is available to set work group to use when the device turns on.

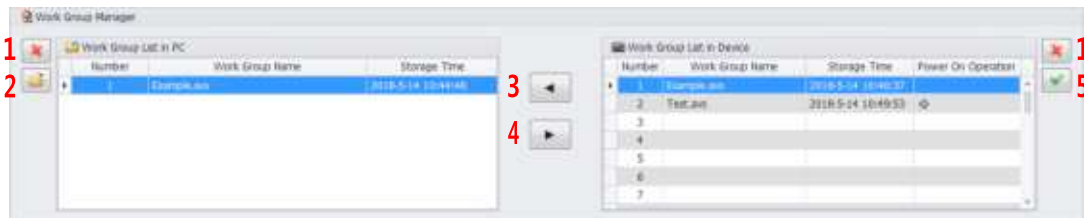

No.	Icon	
1		Deletes selected work group.
2		Selects a folder in the PC to load work group from.
3		Copies work group from the device to the PC.
4		Copies work group from the PC to the device.
5		Selects work group to operate when the device turns on.

- New Work Group: Registers new work group.
- Load Work Group from PC: Loads work group from the local disk of PC. Work groups are saved in the default folder [C:\Users\ (Account name) \Documents\Autonics\Vision Master\Work] or the folder designated by user.
- Save Work Group to PC: Saves work groups registered and set in Vision Master to the local disk of PC. Work groups are saved in the default folder [C:\Users\ (Account name) \Documents\Autonics\Vision Master\Work] or the folder designated by user.

- Load Work Group from Device: Loads work group from the device (vision sensor).

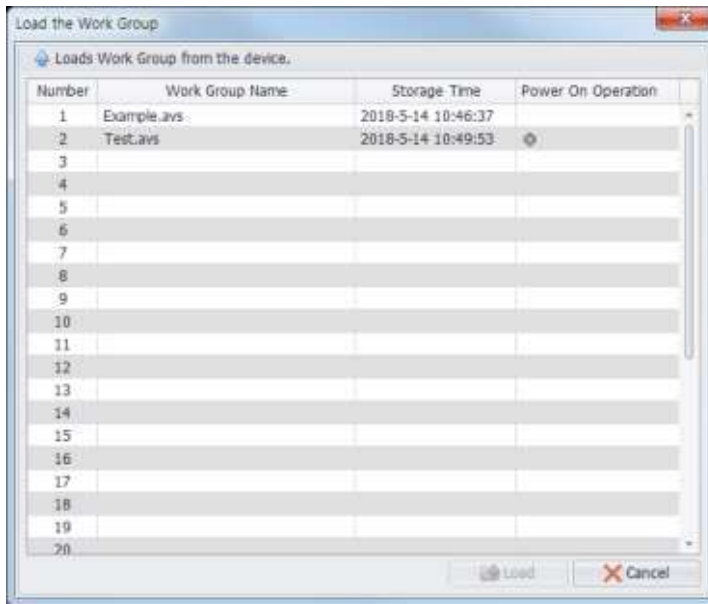

- Save Work Group to Device: Saves work groups registered and set in Vision Master to the device (vision sensor). Click number of work group to save to set the name of work group. At that moment, selected work group can be set as operating work group when the device turns on. Work group can be registered and saved up to 32.

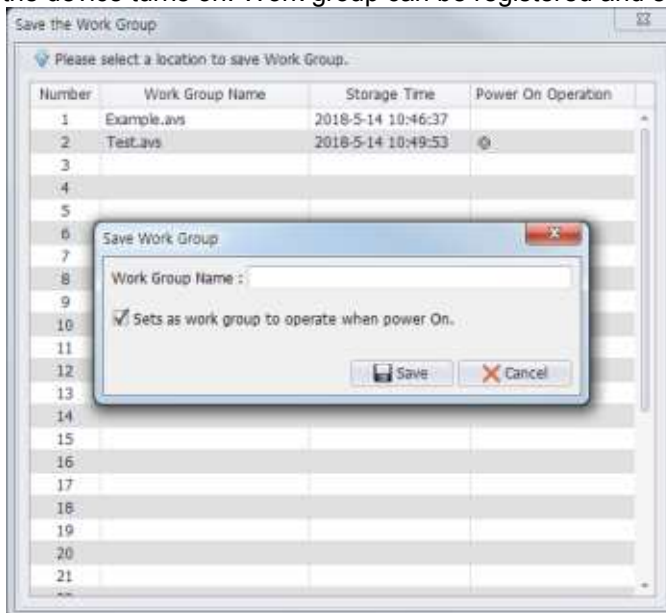

- Exit: Exits Vision Master.

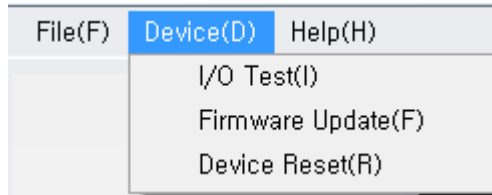
(2) Device

- I/O Test: Displays input status with the indicators (no input: ● / input: ●). Also it is available to set control output type (NPN/PNP) and whether use each output or not. I/O test is only for testing output, so that it is not associated with settings of output parameter

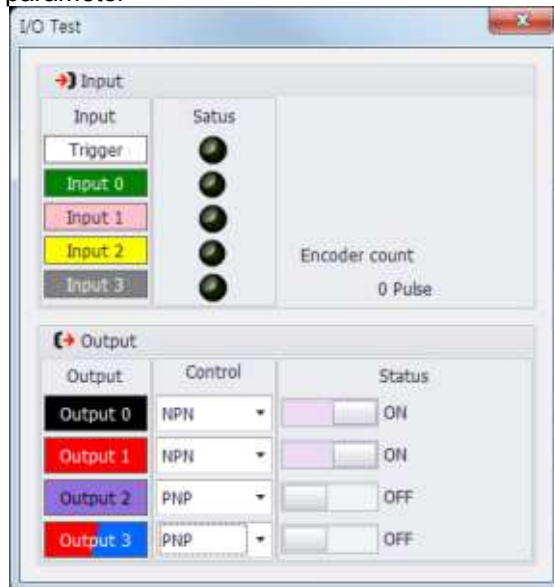



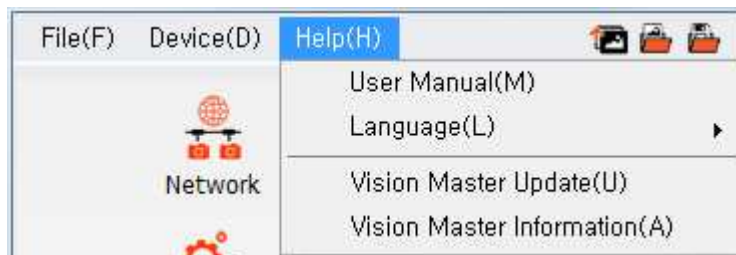



















- Firmware Update: Updates firmware version of the device (vision sensor).
- Device reset: Resets the device, deleting saved work group and set parameters from the device.

(3) Help

- User Manual: Loads user manual.
- Language: Changes program language.
- Vision Master Update: Updates version of Vision Master.
- Vision Master Information: Displays information about version of Vision Master and device firmware.

6.5.2 Toolbar

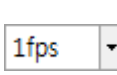
Section	Icon	Description	
1		Open Image	
		Open All Images from Folder	
		Save Image	
2		Work Group Manager	
3		New Work Group	
		Open Work Group from PC	
		Save Work Group to PC	
4*1		Open Work Group from Device	
		Save Work Group to Device	
5		Zoom in	Enlarges image.
		Zoom out	Reduces image.
		Fit to Window	Adjusts the size of the image to fit to the image window.
		Image Scale	Resize image. - Setting range: ×0.5, ×1, ×2, ×4, ×8, ×16
		Full Screen	Displays image in full screen mode. To turn off full screen view, press ESC key or double click mouse button.
6		Show Bar Gauge	Displays the pass range of inspection which set in work group as bar gauge.
7		Multi View (4 channels)*3	Displays inspection status of maximum 4 vision sensors at the same time.
8*1, *2		Snap	Takes an image with the camera of vision sensor.
		Continuous Snap	Takes multiple images with the camera of vision sensor, according to the set number of frame per second (fps).
9		Backward	Loads previous image from images in preview window.

Section	Icon		Description
		Play	Loads images consecutively from images in preview window.
		Forward	Loads next image from images in preview window.
		Image Play Speed	Selects the image playing speed for displaying images from preview window. - Setting range: 4fps, 2fps, 1fps, 1/ 2fps, 1/4fps
		Pause	Pauses playing of images from preview window.
10※1		Add Taken Image to Preview Window	Adds taken images to preview windows.

※1. It is not displayed in simulator operation.

※2. It is displayed only when the camera trigger mode is set to 'free-run trigger' or 'internal trigger'.

※3. Use Multi View function as flows.

1st Click Multi View icon () to open Multi View window as flows.

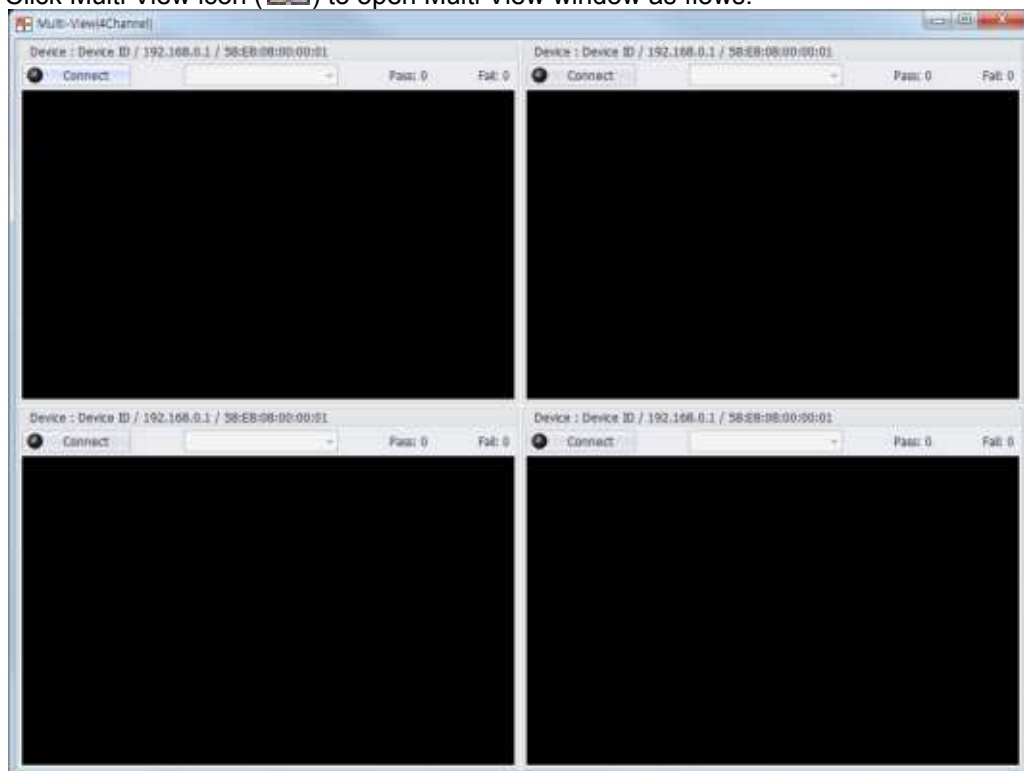

2nd Click  on the top.



3rd Select the device to connect.

You can only select devices which of the connectable status indicator is turned on in green color.

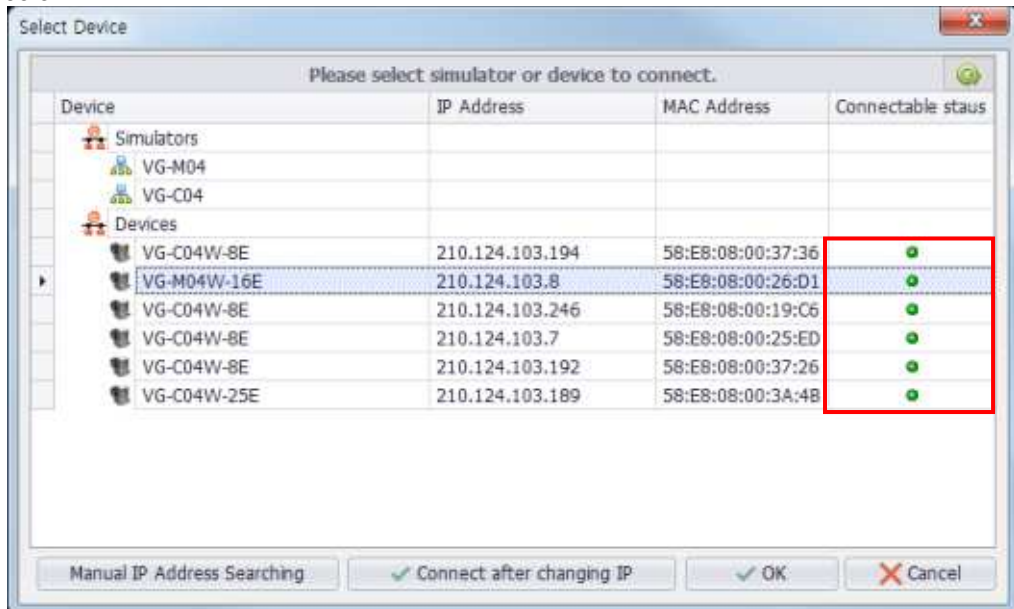

4th Set View Result Image.

Inspection result of the running device (vision sensor) is displayed in the image window.

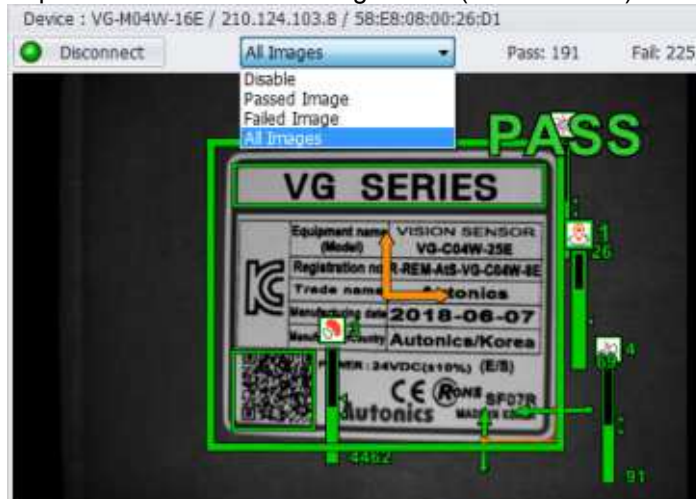

5th You can monitor statistics of Pass/Fail result.

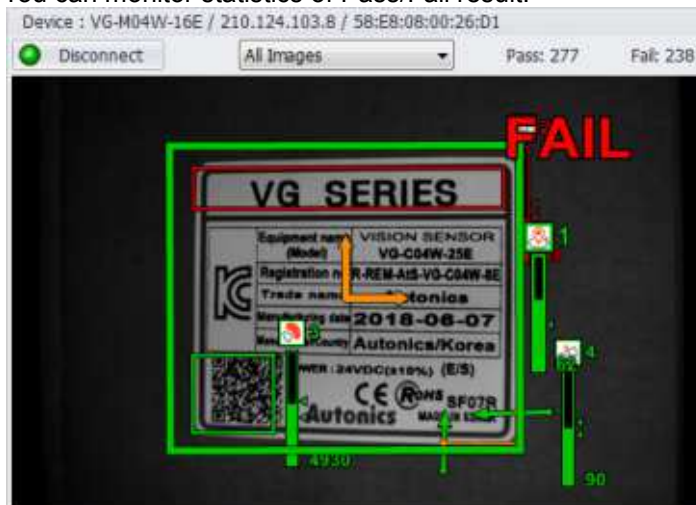

6th You can monitor inspection status of maximum 4 vision sensors at the same time.

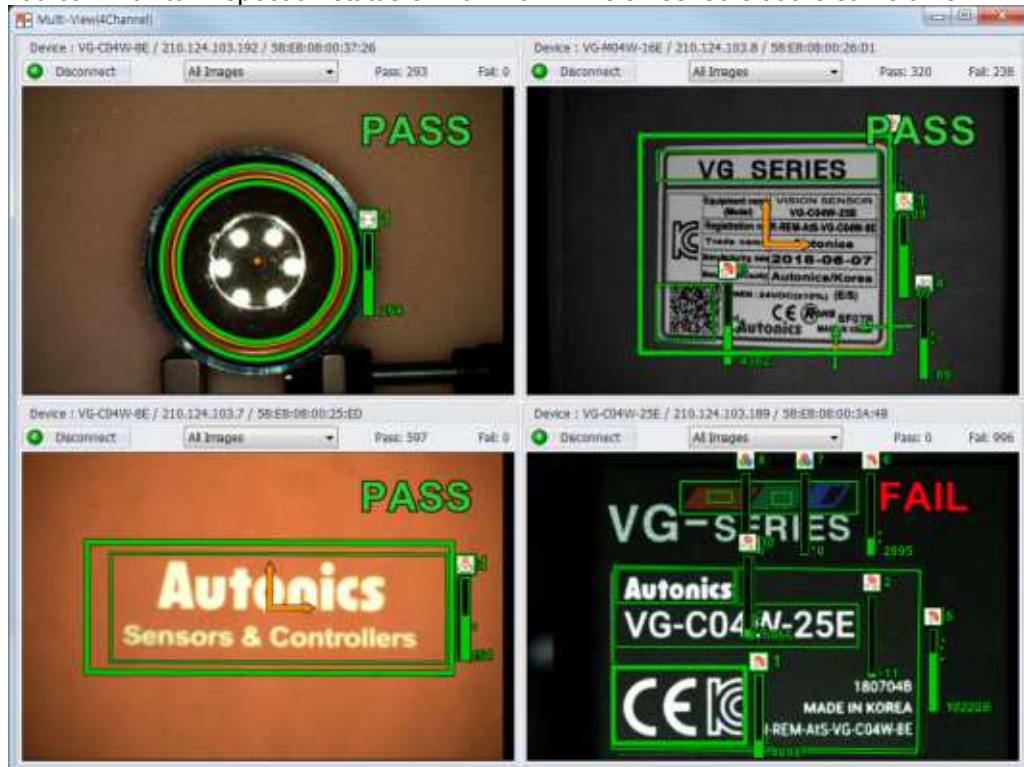

6.6 Setting Menu

6.6.1 Network

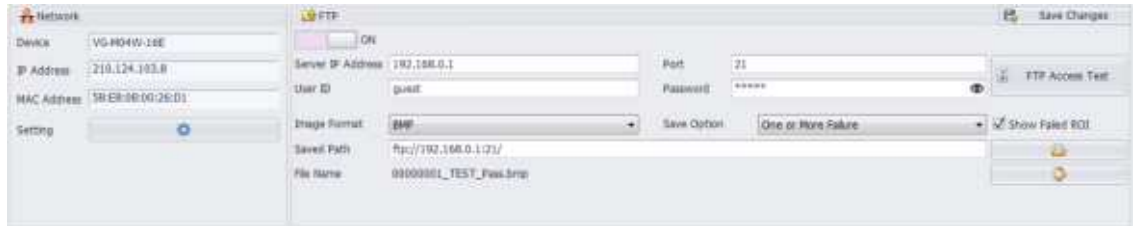
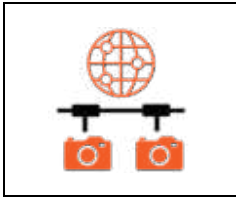

(1) Network

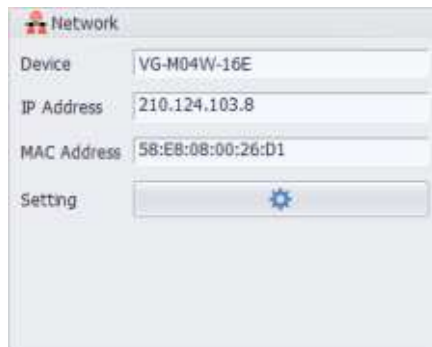

It is available to set vision sensor and PC network.

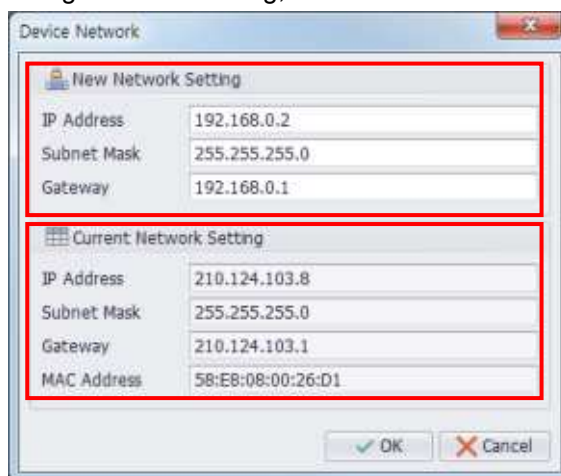

- Device: Displays currently connected vision sensor to Vision Master.
- IP / MAC Address: Displays IP / MAC address of the connected device.
- Setting: Changes IP address setting of the currently connected device. [Current Network Setting] is network information of the currently connected device. To change network setting, enter new information in [New Network Setting].



(2) FTP

Transmits inspection result images saved in vision sensor memory to FTP server.

Select whether to use FTP function or not. (ON / OFF)

- Server IP Address / Port: Enter IP address and port of FTP server.
- User ID / Password: Enter user ID and password.
 - ※If Show Password icon () is clicked, being entered password is displayed in characters, not ' * '.
- FTP Access Test: Checks status of connection to FTP server.
- Image format: Select image format to be saved when transmitting image to FTP server. You can select between BMP (*.bmp) and JPG (*.jpg).
- Save Option: Sets conditions for saving images.
 - All Pass: Only saves images which pass all the inspection items in work group.
 - One or More Failure: Saves images which failed to pass one or more among inspection items in work group.
 - ※If Show Failed ROI check box is checked, ROI which failed to pass inspection is marked in the result image.
- Saved Path: Enter location in server to save the result image.
 - ※When designating folder to upload, click 'Upload Folder Path' icon () on the right side. You can see the list of folder in the server.
- File Name: Sets file name of image to transmit to the FTP server. Click 'Image File Naming Rule' icon () on the right side to set name.



Note

Image file naming rule is as flows.

Item can be set up to 5, and you can customize the order of the items.

Image File Naming Rule

Item 1 : Image Number

Item 2 : Image Name TEST

Item 3 : Inspection Result

Item 4 : Work Group Number

Item 5 : Work Group Name

Example 00000001_TEST_Pass_01_Example_bmp

1 2 3 4 5 6

OK Cancel

- Image Number: It is number of taken image. It is necessary for image file naming.
- Image Name: User can set image name using only Korean, English alphabet, number, and some of special characters (except " < > ? * / \ |)
- Inspection Result: Displays inspection result of Pass/Fail.
- Work Group Number / Work Group Name: Displays number and name of inspecting work group.
- Image format filename extension: It is image format filename extension. It displays BMP (*.bmp) or JPG (*.jpg).

6.6.2 Camera

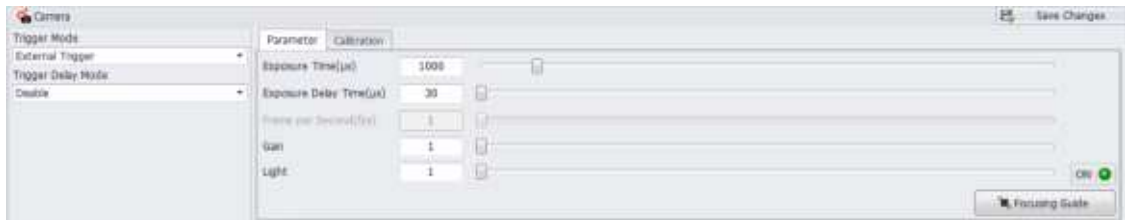
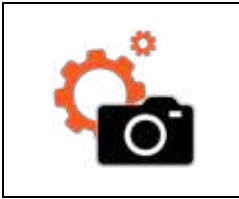

6.6.2.1 Trigger

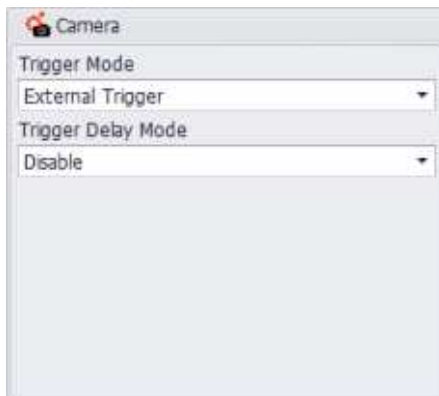

(1) Trigger mode



- Free-Run trigger: Takes images with the maximum trigger speed that can occur in the sensor. (fixed to 60fps)
- Internal Trigger: Takes image by occurring trigger in the sensor (1 to 60fps)
- External Trigger: Takes image with external input signal as trigger. If you use external trigger mode, you can use trigger delay mode.

(2) Trigger Delay Mode

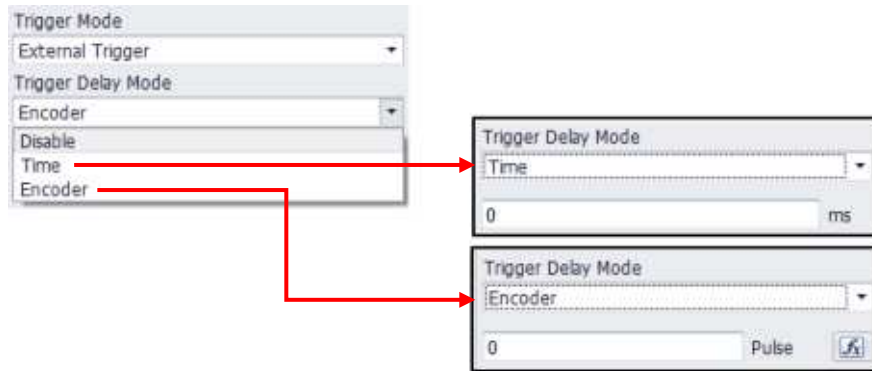

Trigger delay means delayed time from inputting moment of external trigger to actual starting moment of image taking.

- Time: Sets the trigger delay in time unit. Setting range is from 0 to 60,000ms.
- Encoder: Sets the trigger delay in unit of the number of pulse. Setting range is from 0 to 16,000,000 pulses.

Click 'Encoder Delay Pulse Calculator' () and enter moving distance and distance resolution of encoder to calculate pulse value according to um/pulse or pulse/um setting value.



Note

After setting the trigger delay mode, timing diagram of trigger input is shown as follows.

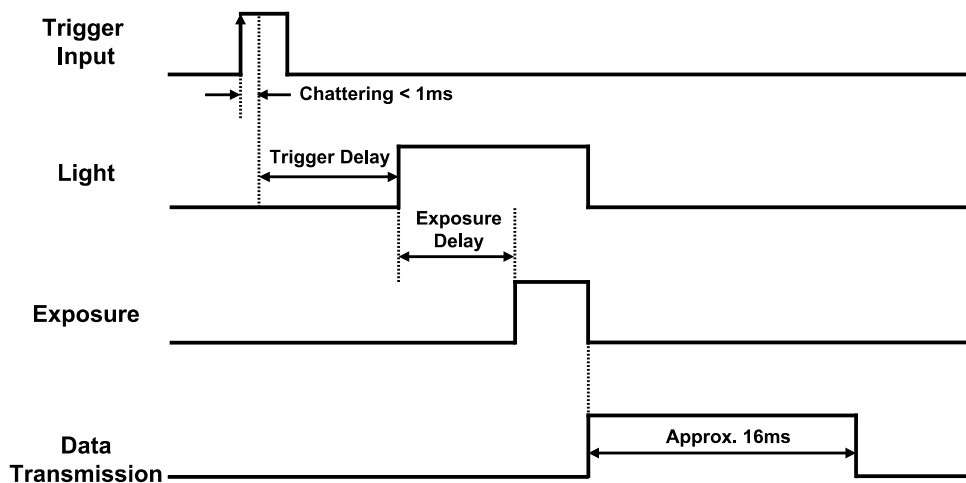

6.6.2.2 Parameter



(1) Exposure time

Exposure time is the time span for which the vision sensor is exposed to the light. The longer exposure time is, the brighter the taken image is, and the shorter exposure time is, the darker the taken image is. Setting range is from 20 to 10,000 μ s.

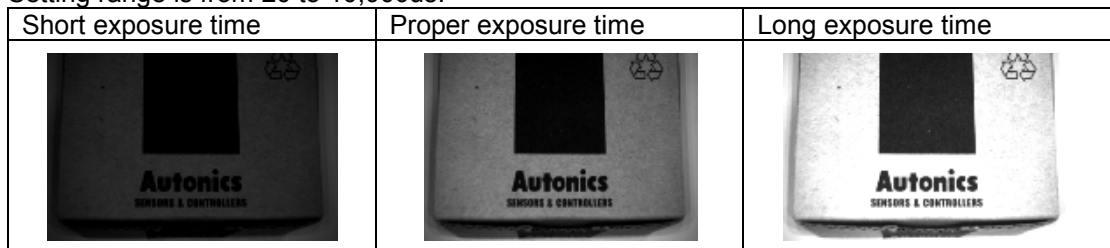

(2) Exposure delay time

Exposure delay time delays the light receiving point of vision sensor. Setting range is from 30 to 10,000 μ s.

(3) Frame per second

Frame per second is Frame rate which is the number of images taken per 1 second. It is settable only when the trigger mode is set to "internal trigger". Setting range is from 1 to 60fps.

※In the external trigger mode, the vision sensor takes images with external input signal, so that you cannot set the frame per second.

※In the free-run trigger mode, the vision sensor takes images at the fastest speed which the vision sensor can.

(The shorter exposure time is, the faster the vision sensor can take.)

(4) Gain



It is adjusting gain of CMOS image sensor.

As higher gain level makes image brighter, increased noises makes resolution low.

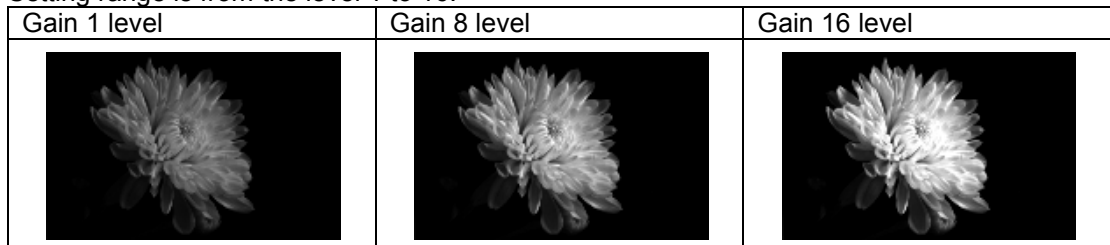
Setting range is from the level 1 to 16.



(5) Light

You can set whether to use inner LED light or not. (Use:  /not use: )
 Light is synchronized with trigger signal and exposure time.
 Setting range is from the level 1 to 16.

Light level 1	Light level 8	Light level 16
		

(6) Focusing guide

Focusing guide makes adjusting image focus with the focus adjuster convenient.
 After setting ROI of the sensing target and checking the focusing guide value, rotate the focus adjuster to the point where the focusing guide value is the highest and fix it at the point to use.



Note

How to adjust focus with focusing guide.

1st Click focusing guide button.

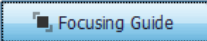
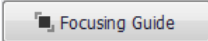
Focusing guide ON () /OFF ()

2nd In the image window, the focusing guide value and area is displayed on the master image.
 Adjust the area to focus on. The higher the focusing guide value is, the clearer focus on the image is.



3rd Click continuous snap () on the toolbar on the top.

4th Checking consecutively taken images, rotate the focus adjuster to the FAR or NEAR direction. Since initial setting is unknown, rotate the focus adjuster to both FAR and NEAR directions and fix the adjuster at the point where the focusing guide value is the highest.



When sensing target is in near → rotate to the NEAR direction.	Focus adjusting is finished.	When sensing object is far → rotate to the FAR direction.
		

6.6.2.3 Calibration



Calibration has two methods of 'actual measurement' and 'approximate measurement'. Since these methods cannot be set at the same time, you have to select one method of them.

Calibration calculates μm per 1 pixel to register.

Since the vision sensor measures distance in unit of pixel, use calibration function for calculating in unit of μm .

(1) Actual measurement

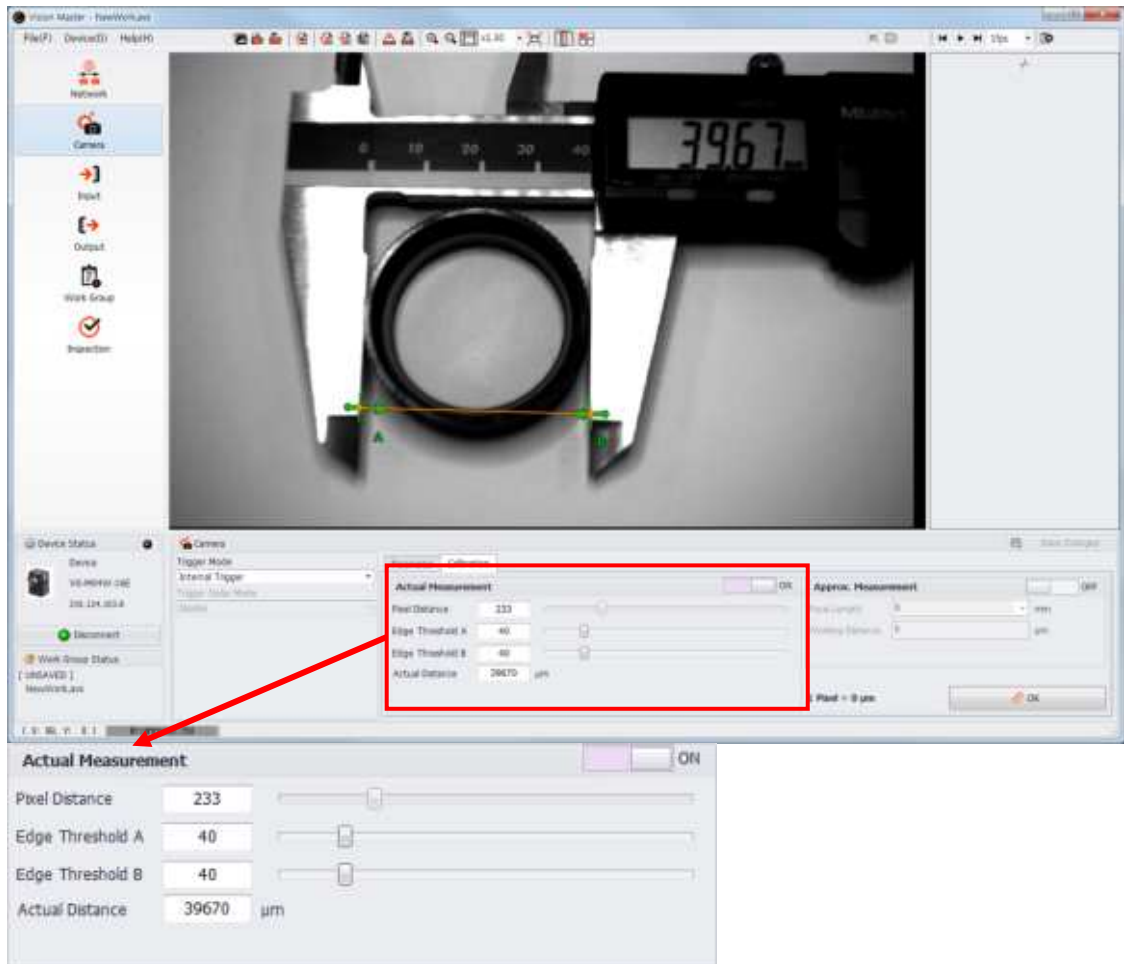

- Pixel Distance: It displays distance between edge A and edge B in pixel.
- Edge Threshold A/B: It is for setting edge threshold to detect edge. With the higher edge threshold value, edge of high contrast is detected, and with the lower edge threshold value, edge of low contrast can be also detected.
- Actual Distance: It is for entering actual distance between two edges in unit of μm .

After setting the edge threshold value and entering the actual distance, click 'OK' () in the right bottom corner to register values after calculating distance per 1 pixel into unit of μm based on the set values in 'Actual Measurement' tab.

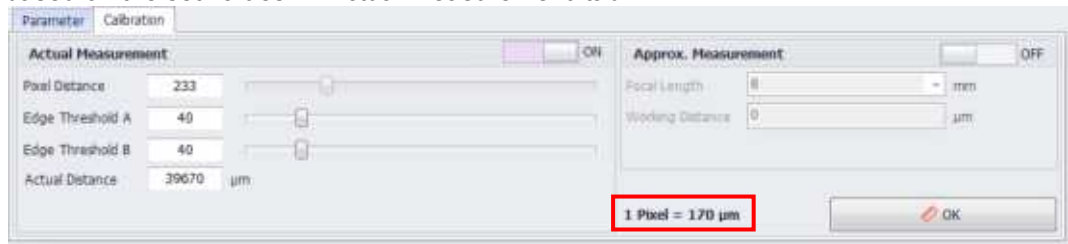

(2) Approximate measurement



- Focal Length: It is for selecting effective focal length of the connected device (vision sensor).
- Working Distance: It is for entering distance between sensing target and the vision sensor.

After selecting focal length and entering the working distance, click 'OK' () in the right bottom corner to register values after calculating distance per 1 pixel into unit of μm based on the working distance and FOV by effective focal length.

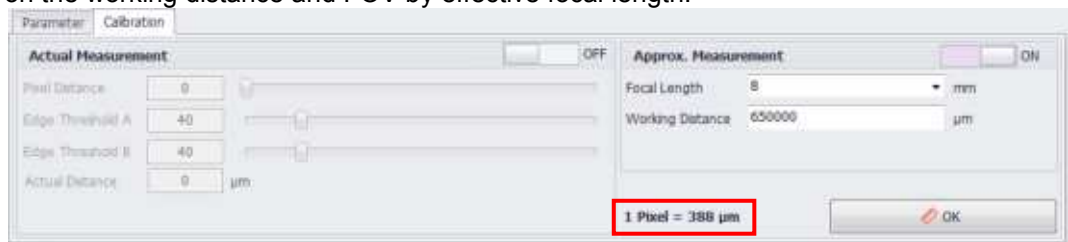

6.6.3 Input

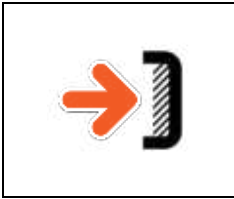

Input	Input Mode	Active Level
Trigger	Camera Trigger	High
Input 0	Work Group Change - Clock	High
Input 1	Work Group Change - Data	High
Input 2	Encoder - Quadrature A	Low
Input 3	Encoder - Quadrature B	Low

(1) Input mode

- Trigger input (TRIG): The selected trigger mode which set in the camera menu is the image taking signal.
- Work group change (IN0 to IN3)
 - Serial input (IN0, IN1): Input 0 and input 1 are set to work group change – Clock or work group change – Data, and work group is changed according to the serial input.
 - Parallel input (IN0 to IN3): From input 0 to input 3 are set to each of work group change bit 0 to 3, and work group is changed according to the parallel input.
- Encoder input (IN2, IN3): After input of trigger signal, the vision sensor takes image after waiting for a while according to the number of encoder pulse. The types of encoder input consist of Up counter/Down counter, and Quadrature. Encoder input is used for the trigger delay mode. Maximum 100kHz input can be recognized.

(2) Active level

According to the active level, trigger is applied at High or Low. To avoid chattering of trigger signal, the vision sensor starts taking an image when the signal is maintained for 1ms.

6.6.3.1 Input mode

Input	Signal	Function	
0	IN0	Work group change Bit 0	Work group change - Clock
1	IN1	Work group change Bit 1	Work group change - Data
2	IN2	Work group change Bit 2	Encoder - Up counter - Quadrature A
3	IN3	Work group change Bit 3	Encoder - Down counter - Quadrature B

(1) Work group change – parallel input (IN0 to IN3)



According to the parallel input, work group is changed.
 With parallel input, work group from 1 to 16 can be changed to.
 (Following table is based on the High active level.)

Input Work group	Bit 3 (IN3)	Bit 2(IN2)	Bit 1(IN1)	Bit 0(IN0)
Work group 1	Low	Low	Low	Low
Work group 2	Low	Low	Low	High
Work group 3	Low	Low	High	Low
Work group 4	Low	Low	High	High
Work group 5	Low	High	Low	Low
Work group 6	Low	High	Low	High
Work group 7	Low	High	High	Low
Work group 8	Low	High	High	High
...
Work group 16	High	High	High	High

(2) Work group change – serial input (IN0, IN1)



According to the serial input, work group is changed.
 Although data is 8-bit, 5 less significant bits are used, because the maximum number of work group is 32.
 With serial input, work group from 1 to 32 can be changed to.

Input \ Work group	Bit 0	Bit 1	Bit 2	Bit 3	Bit 4	Bit 5	Bit 6	Bit 7
Work group 1	0	0	0	0	0	0	0	0
Work group 2	1	0	0	0	0	0	0	0
Work group 3	0	1	0	0	0	0	0	0
Work group 4	1	1	0	0	0	0	0	0
Work group 5	0	0	1	0	0	0	0	0
...
Work group 32	1	1	1	1	1	0	0	0

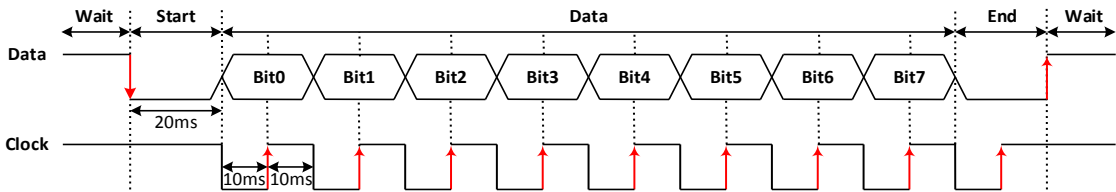

- Start bit: Start bit holds the data signal at Low (Falling edge) for 20ms.
- Clock bit: Clock bit is pulse of 20ms interval which acquires data at the Rising edge.
- Data bit: Data bit is synchronized with Falling edge of the clock signal and holds Low or High for 20ms.
- End bit: After 8th data, end bit holds the data signal for 20ms.



Ex.

When changing work group of the vision sensor to work group 6 with the serial input signal, input the data signal as follows.

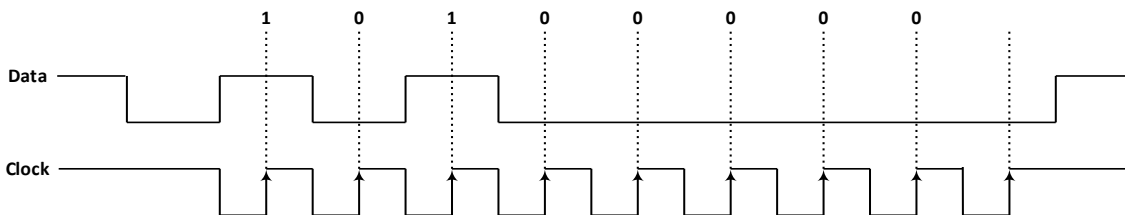

Input \ Work group	Bit 0	Bit 1	Bit 2	Bit 3	Bit 4	Bit 5	Bit 6	Bit 7
Work group 6	1	0	1	0	0	0	0	0

(3) Encoder input

You can use encoder input when you want to use the trigger delay mode of external trigger input on encoder pulse.

Camera trigger occurs after calculating moving distance according to the number of input pulse.

- Up counter/Down counter (IN2, IN3)

Input	Input Mode	Active Level
Trigger	Camera Trigger	J High
Input 0	Disable	J High
Input 1	Disable	J High
Input 2	Encoder - Up counter	J Low
Input 3	Encoder - Down counter	J Low

Input 2 and input 3 are used as each of encoder input up counter and down counter. The number of pulse is counted up or down according to the active level. If you use only one encoder input, connect unused input terminal to COMMON. Rising edge is counted in the high active level, and falling edge is counted in the low active level.

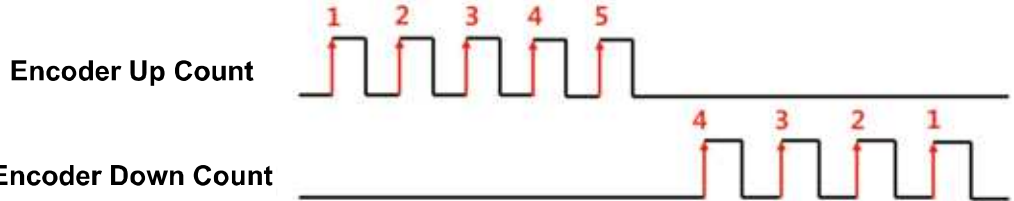

- Quadrature A/Quadrature B (IN2, IN3)

Input	Input Mode	Active Level
Trigger	Camera Trigger	J High
Input 0	Disable	J High
Input 1	Disable	J High
Input 2	Encoder - Quadrature A	J Low
Input 3	Encoder - Quadrature B	J Low

Input 2 and input 3 are operated in encoder Quadrature. Both rising edge and falling edge of two encoders are counted.

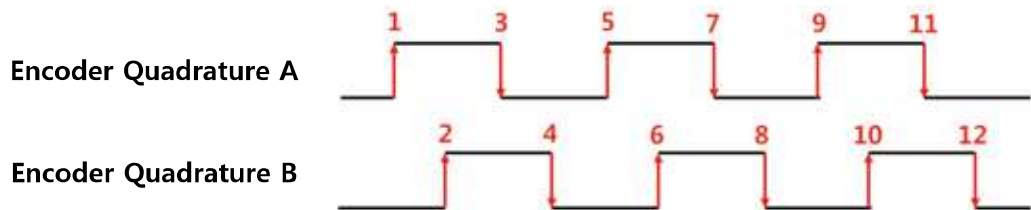

6.6.4 Output

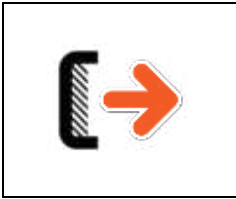

Output	Output Mode	Control Output	Pulse Type	Duration(ms)	Delay Type	Delay Time(ms)
Output 0	Disable	NPN	J.L.N.O.	Latch	10	After Inspectio...
Output 1	Inspection Result	NPN	J.L.N.O.	Pulse	10	After Trigger L...
Output 2	Inspection Complete	NPN	J.L.N.O.	Pulse	10	After Inspectio...
Output 3	Alarm	NPN	J.L.N.O.	Latch	10	After Inspectio...

(1) Output mode

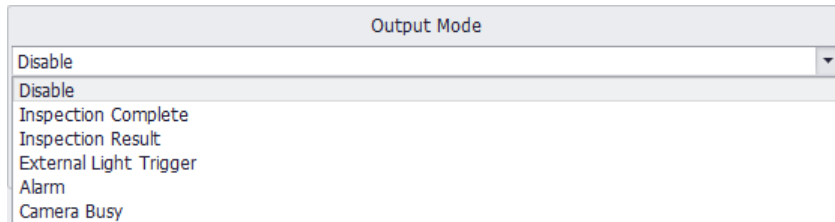

- Inspection Complete: Regardless of the inspection result, the vision sensor outputs output signal at the moment of inspection completion.
- Inspection Result: According to the settings of Output Inspection Result Selection, the vision sensor outputs output signal. Please refer to '6.6.5 Work Group'.

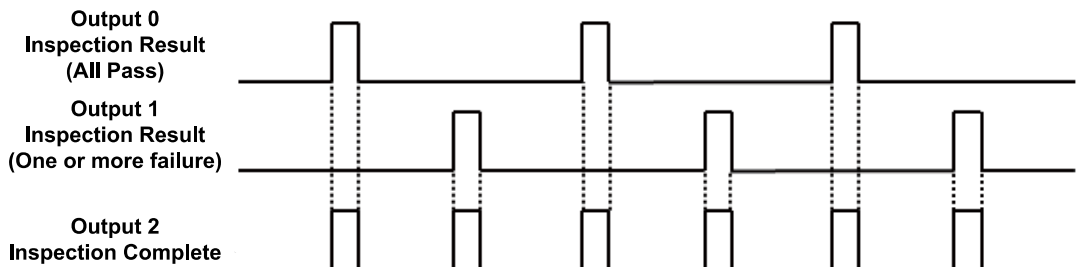

- External light trigger: When connected with the external light, power of the external light is turned ON/OFF with output signal from the vision sensor which is synchronized with camera trigger input.

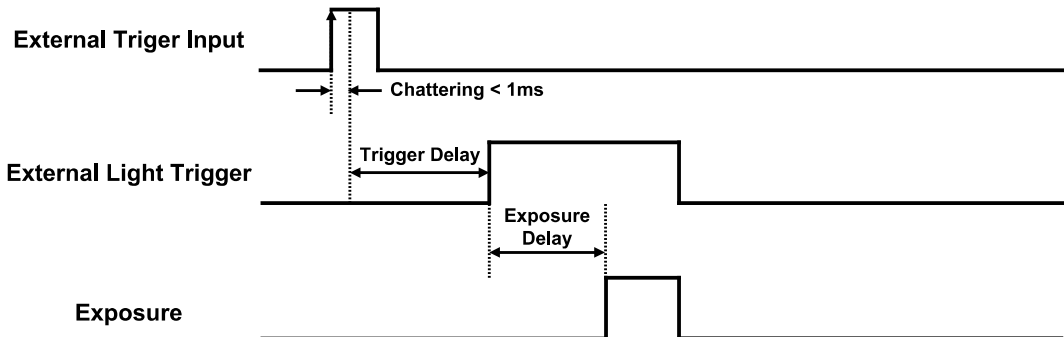

- Alarm: In occurrence of vision sensor error, the vision sensor outputs output signal.

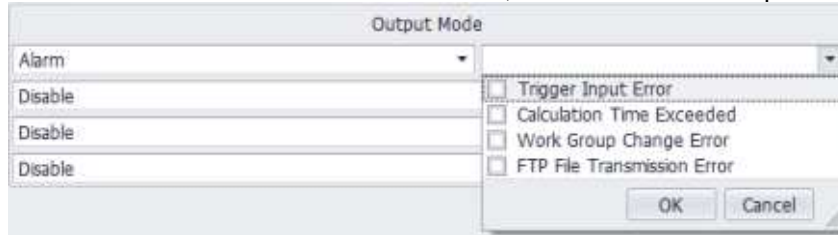

Alarm output	Description
Trigger input error	When trigger is input in high camera busy signal, the vision sensor outputs alarm.
Operating time exceeded	When operating time of work group is exceeded set inspection time, the vision sensor outputs alarm.
Work group change error	When unregistered work group number is entered or wrong Clock or Data is input in serial or parallel input, the vision sensor output alarm.
FTP file transmission error	When FTP access error or FTP transmission error in saving inspection result occurs, the vision sensor outputs alarm.

- Camera busy: It is operating status of the camera, after camera trigger input.

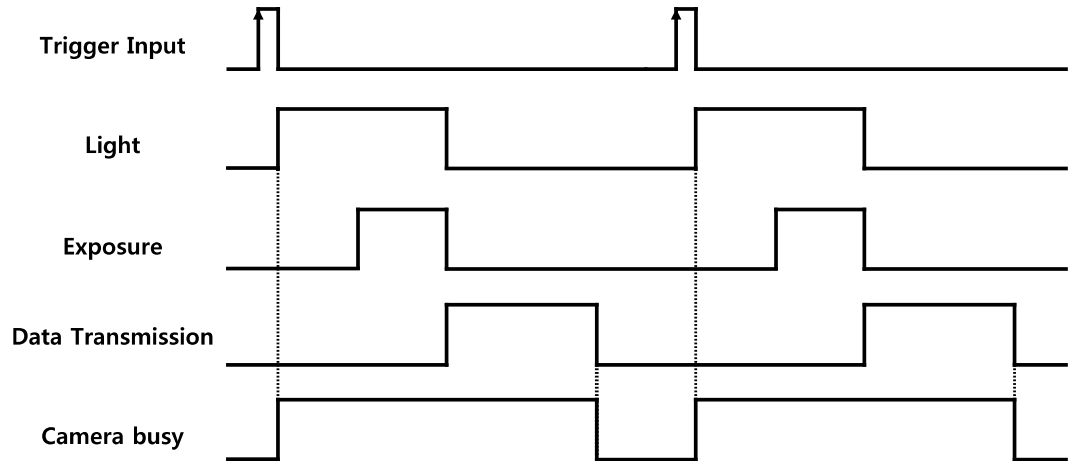

(2) Control output

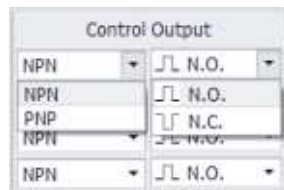

You can set control output to NPN/PNP and N.O.(Normally open) / N.C(Normally close).

(3) Pulse type

You can select pulse type for output.

You can select pulse type only when the output mode is set to 'Inspection complete', 'Inspection result', or 'Alarm'.

- Pulse: Output signal is output during set output duration.
- Latch: Output signal is kept outputting before next output signal.

(4) Duration

Duration is the time period of maintaining inspection result output signal for. You can set duration by setting output mode to "Inspection result" and pulse type to "Pulse". Setting range is from 1 to 60,000ms.

- Timing diagram of output duration (ms).

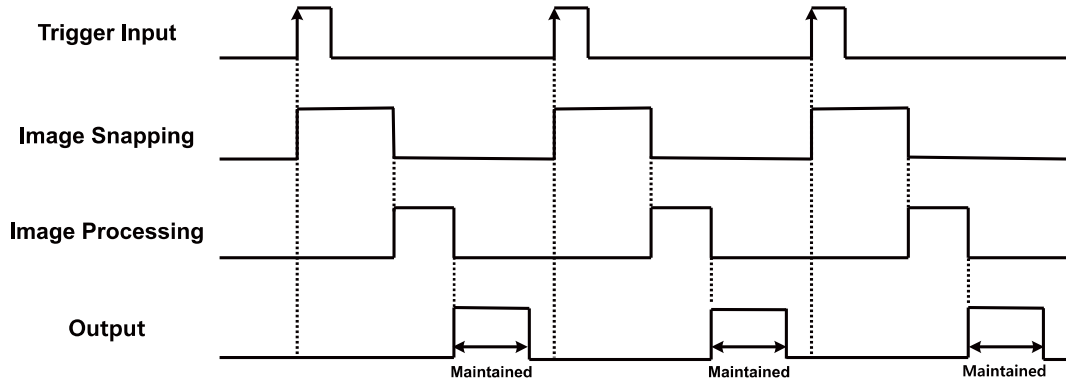
**(5) Delay type**

Delay type is the moment of applying output delay time to. You can set whether to delay output after inspection completed or to delay output after trigger input.

- Delay output after inspection completed

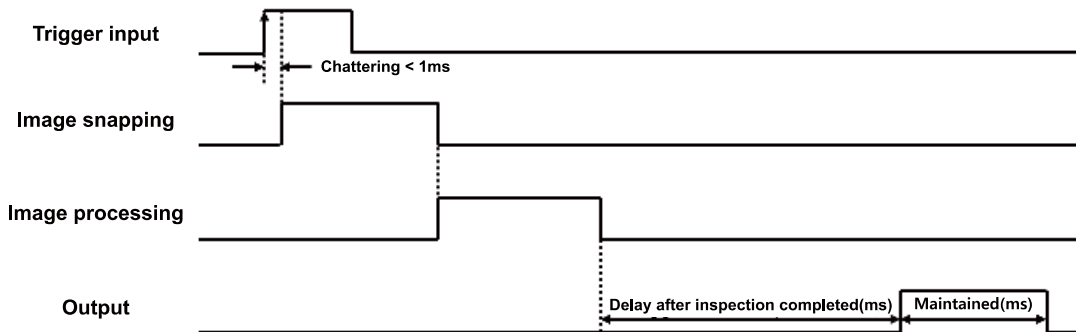

- Delay output after trigger input

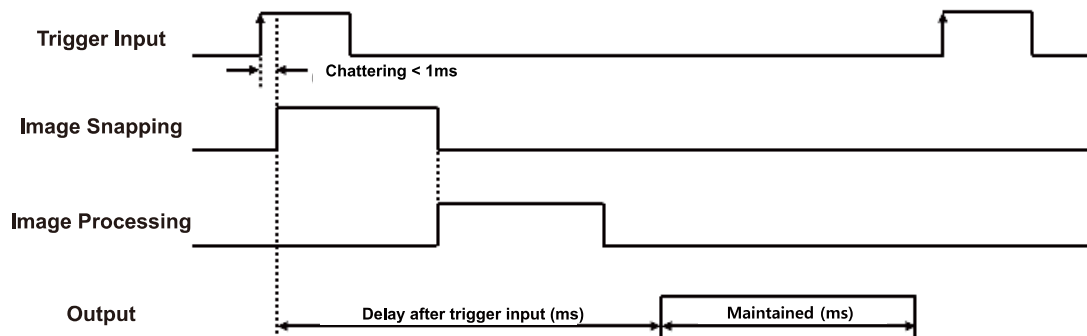
**(6) Delay time**

Delay time is the time period of delaying inspection result output for, after starting of output delay operation.

- Setting range when delay type is "After inspection completed": 0 to 60,000ms
- Setting range when delay type is "After trigger input": 17 to 60,000ms

6.6.5 Work Group

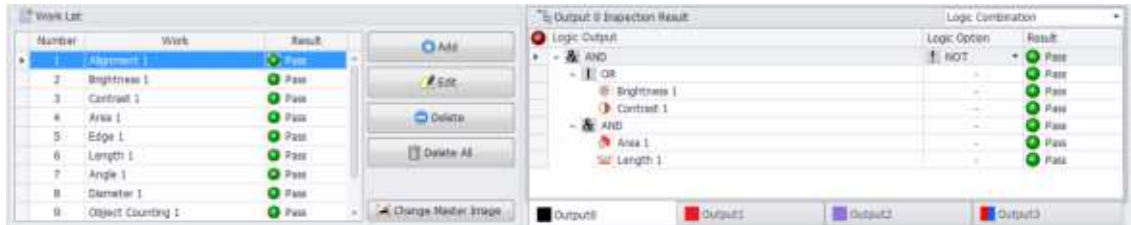

(1) Work list

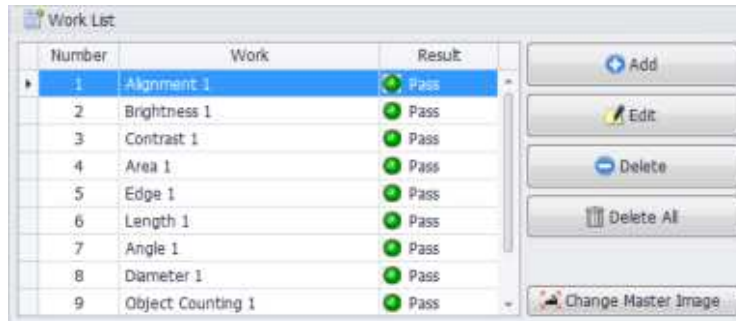

Work list displays a list of the currently registered works and you can register work to inspect and edit or delete the registered works in Work list.

- Add: You can register work to inspect. Select inspection type and register. When making new work group and adding work, an image in the image window is registered as master image.

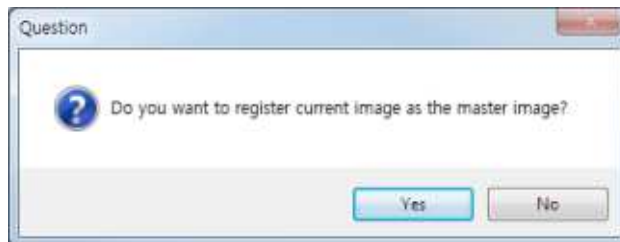

Please refer to '6.7 Inspection ' for inspection item setting.

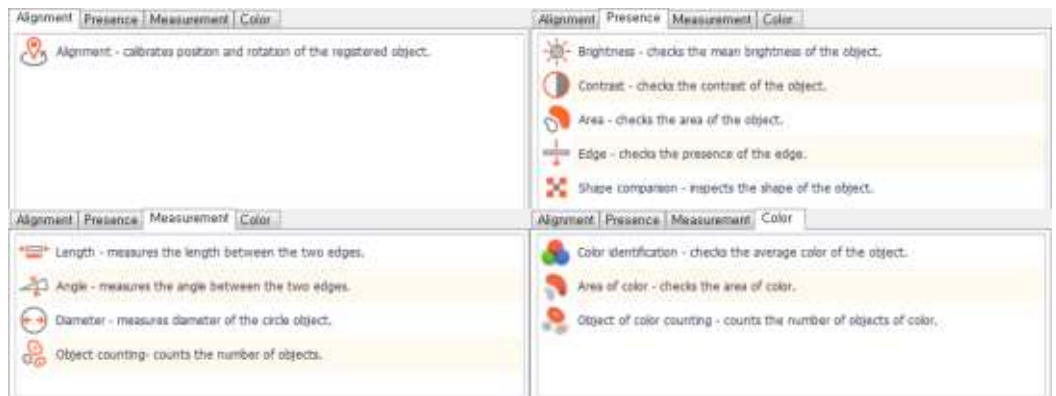

- Edit: Select the registered work in the list and click Edit to edit the work.
- Delete / Delete All: Select the registered work in the list and delete a work or delete all works.

Change master image: You can change image template of the work to register. The currently displayed image in the image window is registered as master image.



Note

You can copy and paste registered works in the work list by using Ctrl+C and Ctrl+V.

It is except for Alignment 1 work.

- 1st Select a work to copy, and press Ctrl+C key to copy.
e.g.) Brightness 1

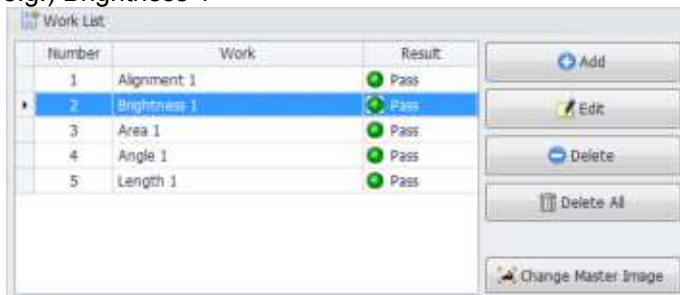

- 2nd Press Ctrl+V key to open the message pop-up as below, and click 'OK'.

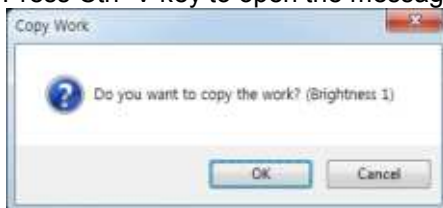

- 3rd The work is copied.

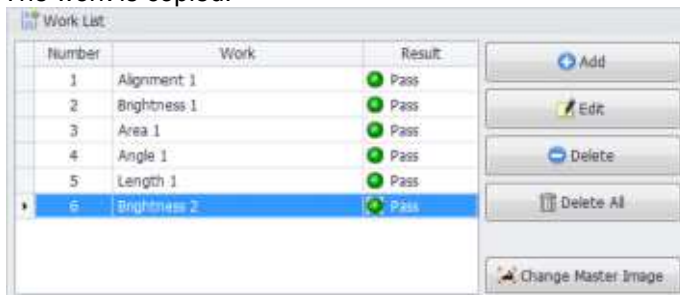

- 4th Select the copy of the work and click 'Edit' to change specific settings of the work.

(2) Output inspection result selection

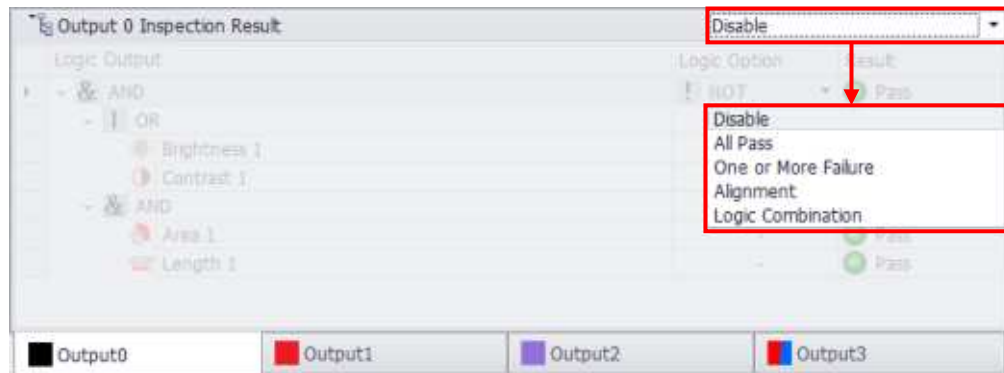

Set output mode in output menu to “inspection result” and set outputting condition among followings.

- Disable
- All pass: When all of inspection results are passed, the vision sensor outputs output signal.
- One or more failure: When one or more inspection result is failed to pass, the vision sensor outputs output signal.
- Alignment: When inspection items with alignment are passed, the vision sensor outputs output signal.
- Logic combination: You can set output conditions by setting each logic combination to pass or fail with logical operator.



Note

When setting output with logic combination, set output condition using logical operator for each output.

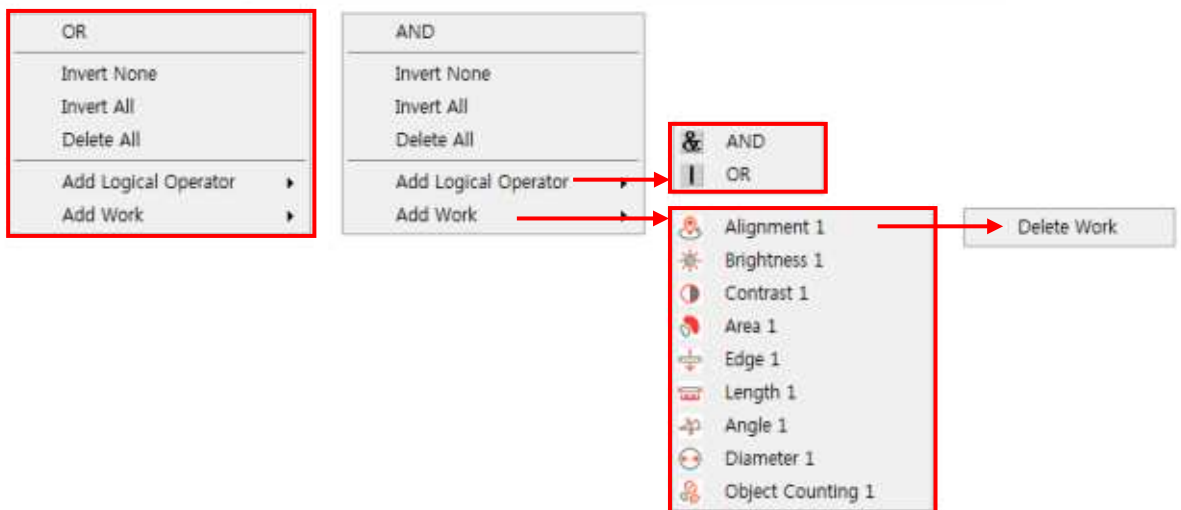
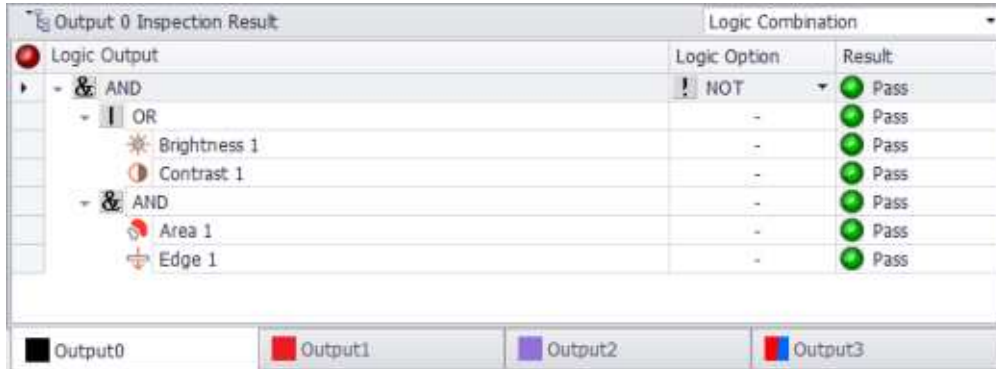

- AND/OR: You can select logic operator.
- Invert none: You can set logical option of all work to NONE(-).
- Invert all: You can set logical option of all work to NOT.
- Delete all/Delete logical operator: You can delete all registered settings of with Delete all and registered logic operator with Delete logical operator.
- Add logical operator: You can add logical operator (AND/OR).
- Add work/Delete work: You can add registered work to logical output or delete work from logical output.

6.6.6 Inspection



Number	Work Name	Result value	Result	Pass/Fail	Operating Time(ms)
1	Alignment 1	91 [x:387 Y:236 R:0.1]	●	352/6(97.7%)	589.25
2	Brightness 1	155	●	331/29(91.9%)	0.30
3	Contrast 1	68	●	344/18(95.3%)	1.03
4	Area 1	2058	●	345/15(95.8%)	0.36
5	Edge 1	0 [Distance:3]	●	296/64(82.2%)	-9.80
6	Length 1	384	●	231/29(91.9%)	20.41
7	Angle 1	91	●	346/14(96.1%)	23.17
8	Diameter 1	68 [Round:92]	●	344/18(95.3%)	67.59
				2934/308(96.5%)	743.48

(1) Device

- Start/Stop device inspection: You can activate vision sensor in operation mode and start inspection in registered work group.



- View result image: You can set image to display in the image window during inspection.

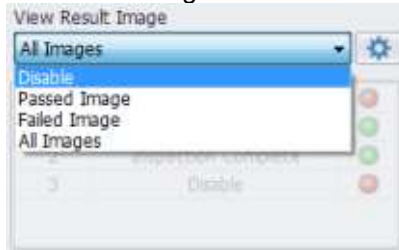

- Save result image: Click the 'Save result image' icon (gear icon) on the right side in View result image. You can set the result image in local disk of the PC.

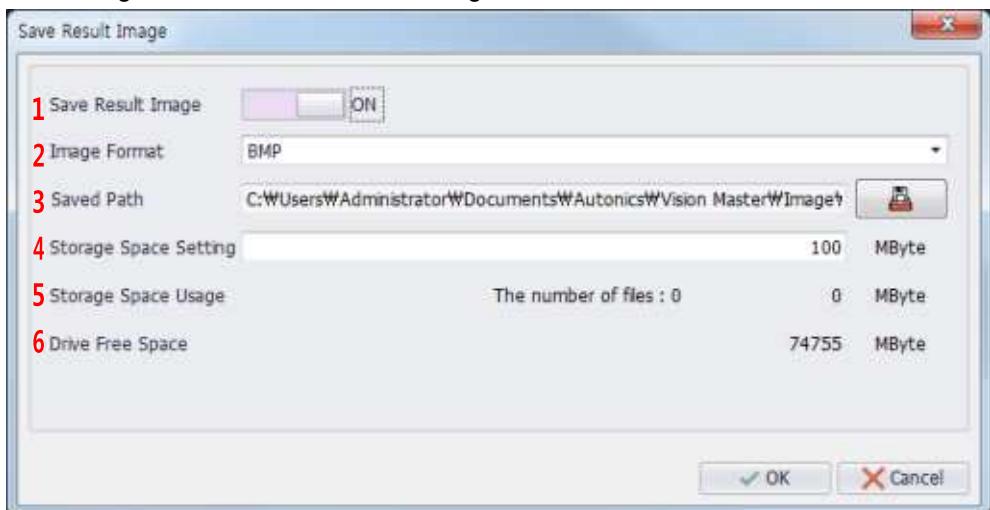

No.	Item	Description
1	Save result image	Sets whether to save inspection result image.
2	Image format	Selects image format to save in. (BMP, PNG, JPG)
3	Saved path	Selects saved path in which result images are saved. Click  on the right to select saved path.

No.	Item	Description
4	Storage space setting	Checks drive free space and allocates space to save.
5	Storage space usage	Displays the number and volume of the files in storage space.
6	Drive free space	Displays drive free space of the PC.

- Output status: Output status displays output status during inspection. You can check output mode and operation status of output.

0	Alarm	●
1	Inspection Result	●
2	Inspection Complete	●
3	Disable	●



Note

Please refer to followings when clicking Start device inspection to activate operation mode.

- Select operation mode: It is to set operation when starting inspection. You can select whether to save or not to save before starting inspection. When the device is turned off, you can lose unsaved data.



- Setting of displaying the inspection image in full screen

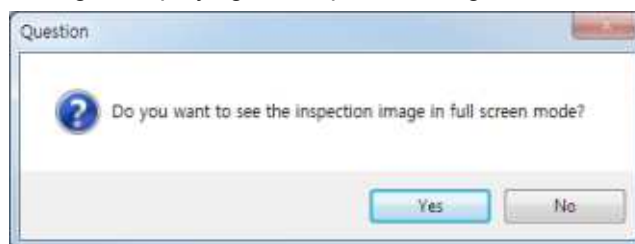

(2) Inspection Status

Number	Work Name	Result Value	Result	Pass/Fail	Operating Time(ms)
1	Alignment 1	82 (X:377 Y:250 R:0.2)	●	103/0(100.0%)	562.72
2	Brightness 1	153	●	78/25(75.7%)	0.19
3	Contrast 1	60	●	87/16(84.4%)	1.02
4	Area 1	5179	●	87/16(84.4%)	0.37
5	Edge 1	0 [Distance:8]	●	94/9(91.2%)	9.63
6	Length 1	0	●	89/14(86.4%)	0.82
7	Angle 1	100	●	100/3(97.0%)	23.00
8	Diameter 1	68 [Round:88]	●	100/3(97.0%)	86.24
				817/110(88.1%)	694.26

Input Trigger		2.3%
Pass	103	
Fail	4352	
Work		46.6%
All Pass	48	
One or More Failure	55	
The Number of Works	9	
Overall Inspection Time(ms)	728	

- Work name: Displays work name of inspection items.
- Result value: Displays measured result value of each work ROI.
- Result: Displays pass/fail for inspection result.
- Pass/Fail: Displays counting of the number of pass/fail and pass rate.
- Operation time: Displays operation time of each inspection item.
- Reset statistics: Resets all statistics about inspection result including pass (●) / fail (●) status and operation time.
- Input trigger: Displays statistics of input trigger. It helps you to check input is operating in normal status by counting the number of pass/fail status of input trigger.
- Work: Displays statistics of work. It displays the number of inspection result of All pass, One or more failure, the number of total work, and inspection time.



Note

When operating device inspection with calibration function, result value of the 'edge', 'length', and 'diameter' inspections are displayed as actual value in the unit of mm, not pixel.













- Inspection result value without calibration function

Number	Work Name	Result Value	Result	Pass/Fail	Operating Time(ms)
1	Edge 1	86 [Distance:1]	●	157/41(79.2%)	11.95
2	Length 1	198	●	166/32(83.8%)	19.27
3	Diameter 1	261 [Round:86]	●	160/38(80.8%)	157.27
				483/111(81.3%)	-

- Inspection result value with calibration function

Number	Work Name	Result Value	Result	Pass/Fail	Operating Time(ms)
1	Edge 1	86 [Distance: 0.15 mm]	●	120/75(61.5%)	11.77
2	Length 1	29.7 mm	●	154/41(78.9%)	19.87
3	Diameter 1	39.15 mm [Round:85]	●	128/67(65.6%)	157.68
				402/183(68.7%)	189.32

6.7 Inspection

Icon	Function	Description
	Alignment	To align position and orientation of the target based on the registered target
	Brightness	To inspect average brightness of the target
	Contrast	To inspect average contrast of the target
	Area	To inspect area of the target
	Shape comparison	To inspect shape of the target
	Edge	To inspect the presence of the edge
	Length	To inspect the length between two edges
	Angle	To inspect the angle between two edges
	Diameter	To inspect diameter of the circle
	Object counting	To count the number of the object
	Color identification	To inspect average color of the object
	Area of color	To inspect area in a certain color
	Object of color counting	To count the number of objects in a certain color

6.7.1 Alignment

You can use the alignment function to align position and orientation of the target based on the registered target.

Alignment compares features of the registered target and features of the input image to figure out location of similar pattern, and then inspects the input image based on location and rotation angle of the target. It is used to check the presence of inspection target to rotate, to inspect pattern, or to align position of the target.

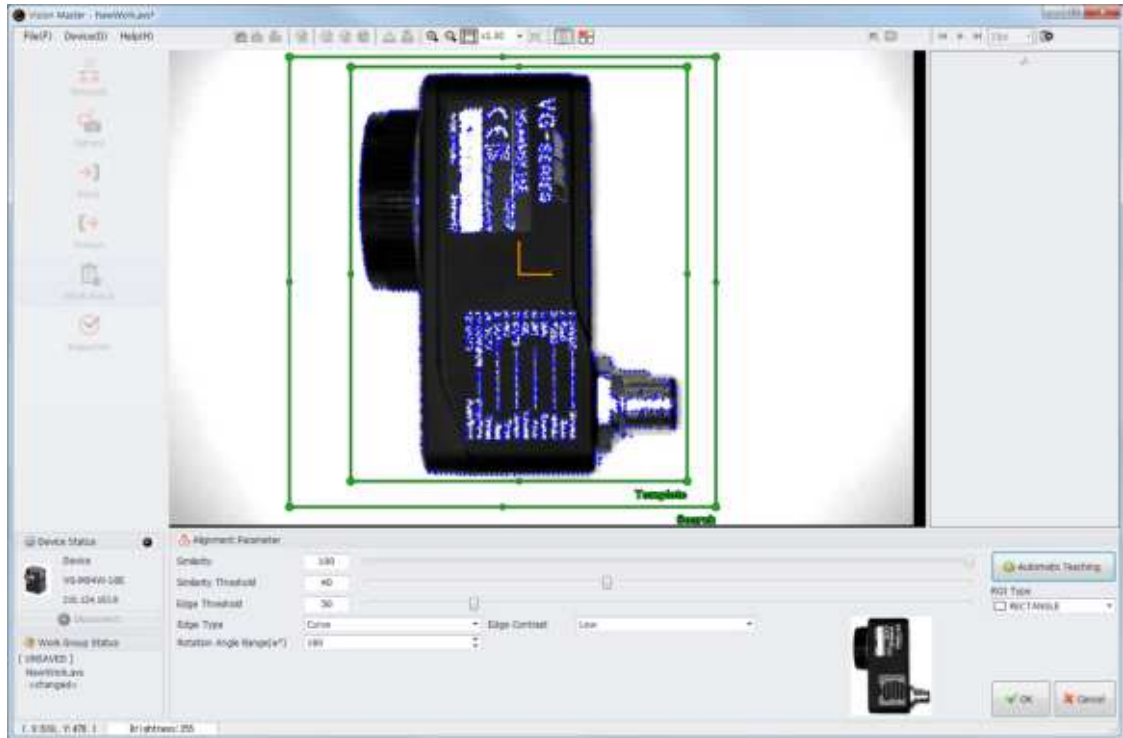

No.	item	Description
1	Similarity	It is the similarity between registered template and detected template.
2	Similarity threshold ^{※1}	It is discrimination value of the similarity for deciding pass/fail.
3	Edge threshold	It is threshold to detect edge. Only edges with high contrast can be detected in high edge threshold, while edges with low contrast also can be detected in low edge threshold.
4	Edge type	It limits amount of information according to the edge direction. - Curve: It leads pixels from all edges. - Straight: It leads pixels only from straight edge.
5	Edge contrast	It limits amount of edge information according to the contrast value. - High: It uses edges of high contrast. - Medium: It uses edges of high and medium contrast. - Low: It uses edges of high, medium, and low contrast.
6	Rotation angle range (±°)	It limits detecting area to the set angle range, by setting angle range of the rotated image to detect.
7	Automatic teaching	It operates teaching automatically, when user changes parameter or adjust ROI.
8	ROI type	After setting ROI (Template), set area (Search) to inspect ROI in it.

No.	item	Description
		It sets type of ROI (Template) to inspect. <input type="checkbox"/> RECTANGLE <input type="checkbox"/> POLYGON <input type="checkbox"/> CIRCLE (rectangle/polygon/circle)
9	OK/Cancel	It registers work to work group or cancel to register.

※Threshold is the boundary value when a value is discontinuously changed.

※1. When set template of ROI is 50% similar with the input image in 50 similarity threshold, the vision sensor regards them as the same target and outputs output signal.



**Ex.**

Examples of pass/fail in the alignment inspection

- Registering template of inspection target (similarity: 100% / similarity threshold: 80%)

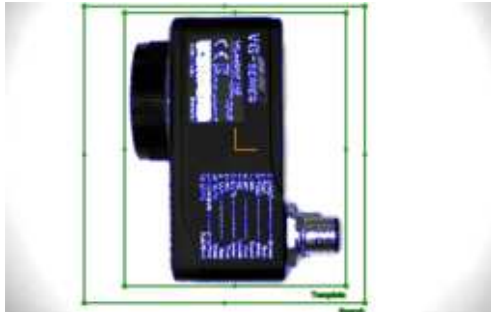

- Passed alignment inspection.



- Failed alignment inspection.





Note

When inspecting inspection items including alignment, alignment is prior to any other inspection items, so that rotating inspection target by alignment also rotates position of other inspection items.



If you want to apply alignment to each inspection, check 'Apply alignment' in the right bottom.

Apply Alignment

X Y R

X: moving X axis coordinate / Y: moving Y axis coordinate / R: angle

Examples of pass/fail when inspecting multiple work including alignment

- Registering template of the inspection target (registering alignment)



- Applying alignment



- Unapplying alignment



6.7.2 Brightness

You can use the brightness function to inspect average brightness of the target.

Brightness compares mean brightness of the registered ROI and that of input image ROI. It sets pass range based on the mean brightness value of the registered ROI. The mean brightness value of the inspection target within the pass range is regarded as Pass, while the mean brightness value of the inspection target out of the pass range is regarded as Fail.

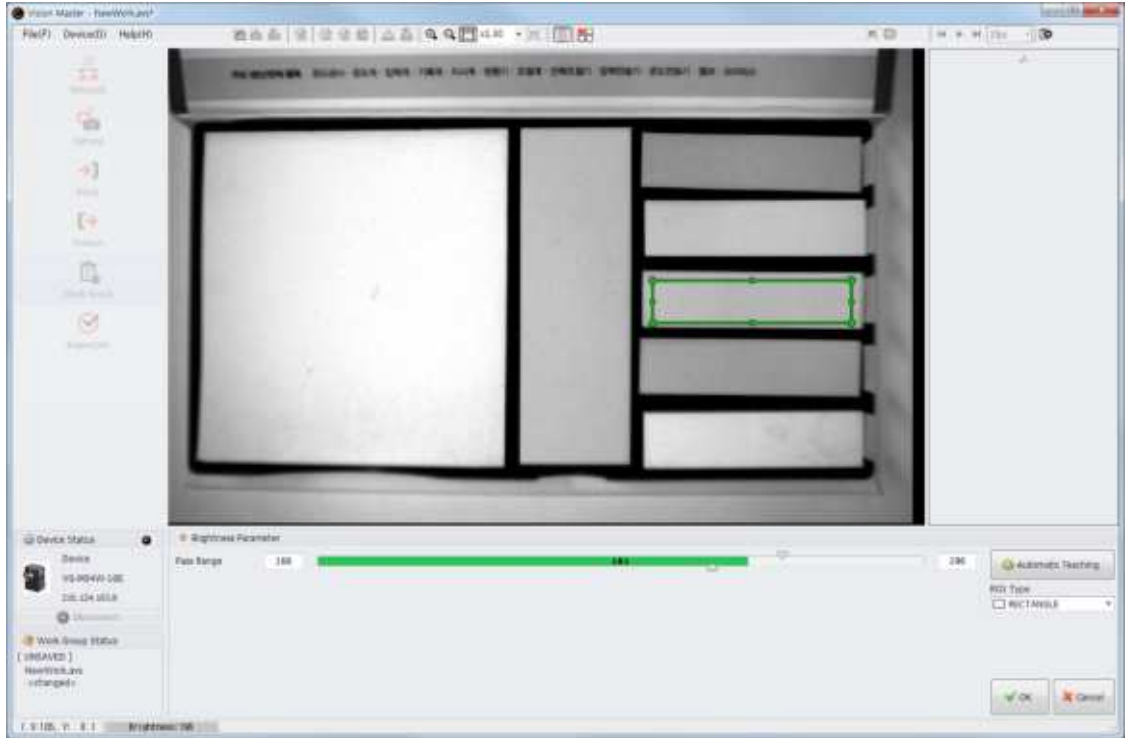

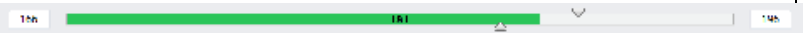
No.	Item	Description
1	Pass range	It sets the pass/fail range of brightness.  Lower limit for pass ROI mean brightness value Upper limit for pass
2	Automatic teaching	Even if user set the pass range, it teaches pass range based on mean brightness of ROI.
3	ROI type	It sets type of ROI to inspect. <input checked="" type="checkbox"/> RECTANGLE <input type="checkbox"/> POLYGON <input type="checkbox"/> CIRCLE <input type="checkbox"/> CONCENTRIC_CIRCLE (rectangle/polygon/circle/concentric circle)
4	OK/Cancel	It registers work to work group or cancel to register.

**Ex.**

Examples of pass/fail in the brightness inspection

- Registering template of the inspection target
(mean brightness: 181 / pass range: 166 to 196)

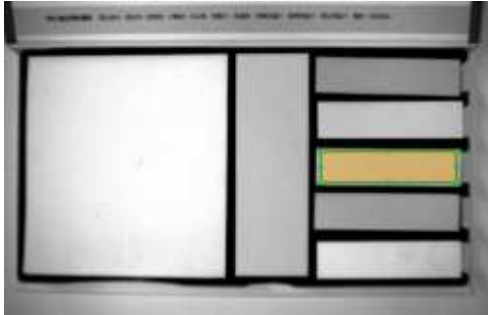

- Passed brightness (alignment applied)

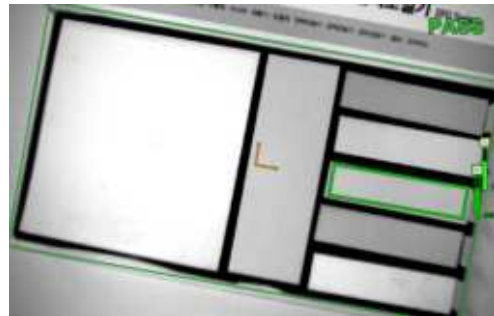
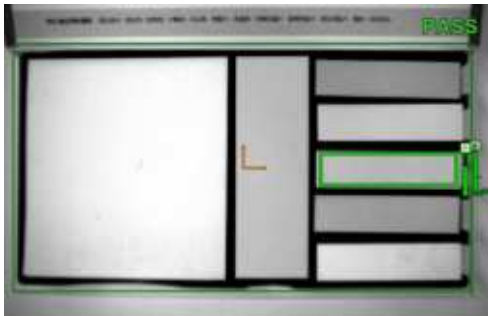

- Failed brightness

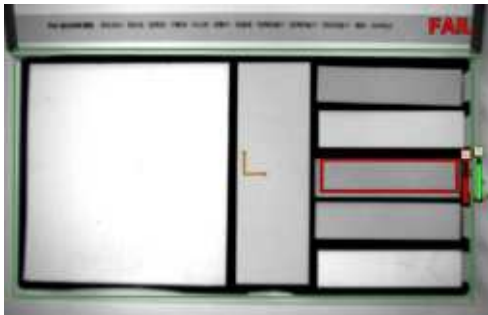

(Reduced ROI area brightness)

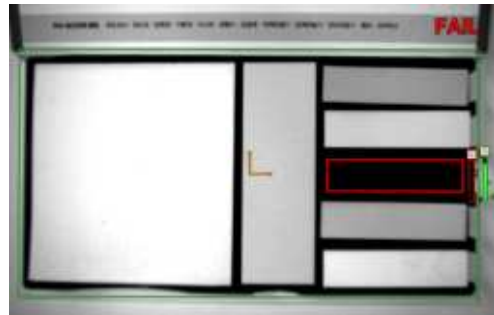

(Below mean brightness of ROI area)

6.7.3 Contrast

You can use contrast function to inspect average contrast of the target.

Contrast is amount of gap between bright part and dark part in the image.

Contrast compares registered ROI contrast and ROI contrast of the input image to figure out changes in contrast. It sets pass range based on the registered contrast value of ROI. The contrast value of the inspection target within the pass range is regarded as Pass, while the contrast value of the inspection target out of the pass range is regarded as Fail. The contrast value is displayed in the percentage.

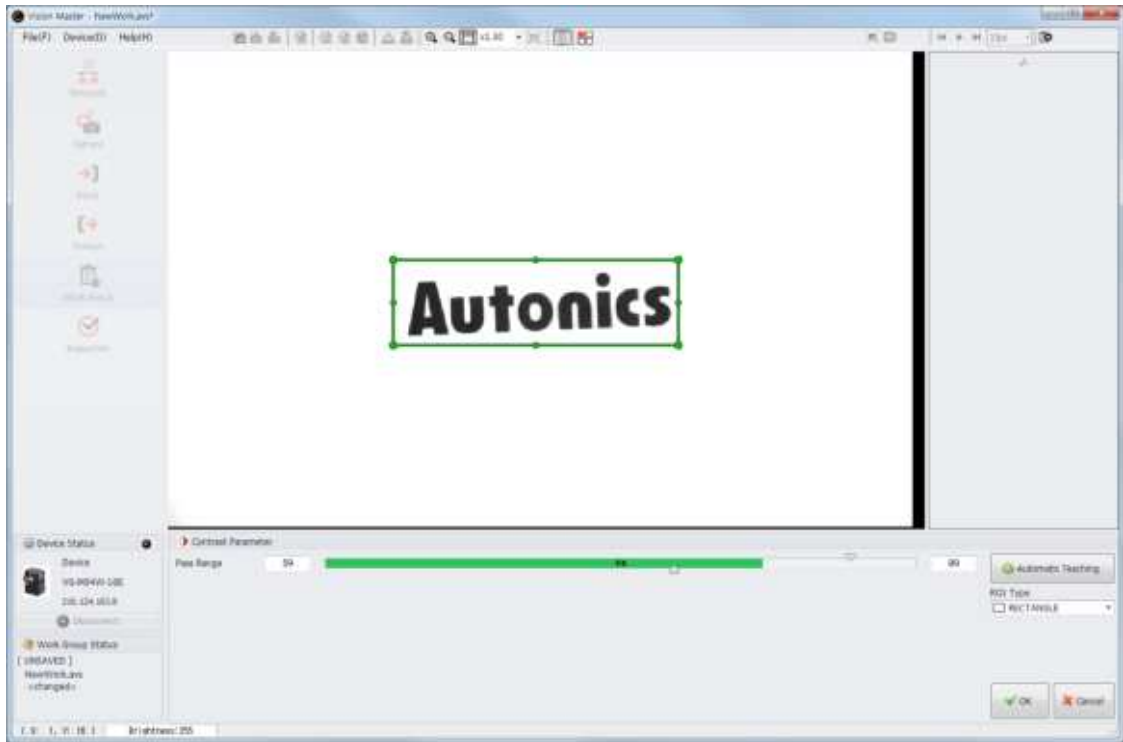

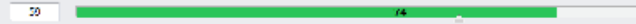
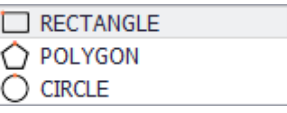
No.	Item	Description
2	Pass range	It sets the pass/fail range of contrast.  Lower limit for pass ROI average contrast Upper limit for pass
3	Automatic teaching	Even if user set the pass range, it teaches pass range based on the average contrast value of ROI.
4	ROI type	It sets type of ROI to inspect.  (rectangle/polygon/circle)
5	OK/Cancel	It registers work to work group or cancel to register.

**Ex.**

Examples of pass/fail in the contrast inspection

- Registering template of the inspection target (contrast: 74 / pass range: 59 to 89)



- Passed contrast (alignment applied)

PASS

PASS



- Failed contrast

FAIL



6.7.4 Area

You can use the area function to inspect area of the target.

Area compares difference between registered ROI area and ROI area in the input image. It sets the pass range based on the registered ROI area. The area of the inspection target within the pass range is regarded as Pass, while the area of the inspection target without the pass range is regarded as Fail.

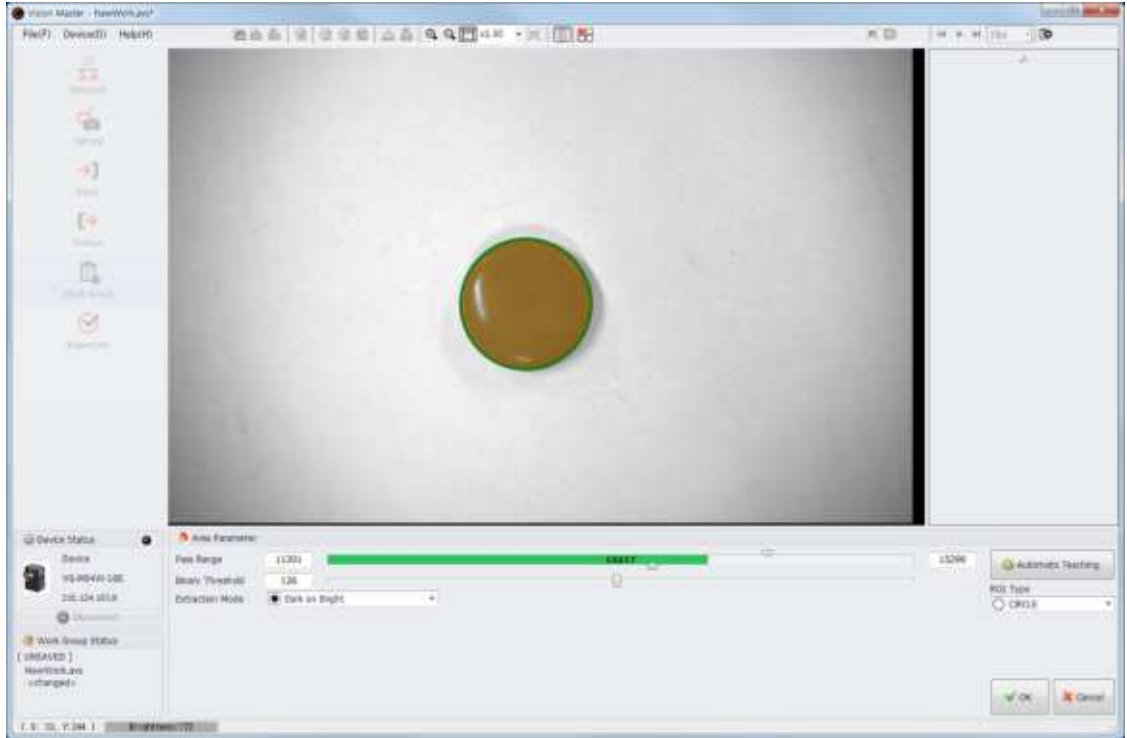

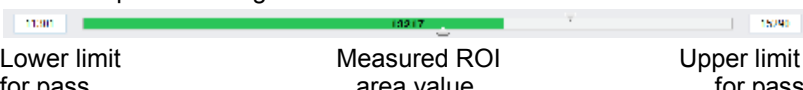
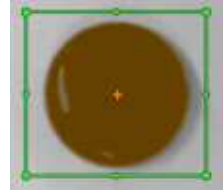
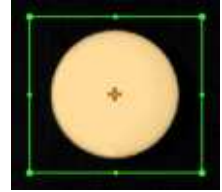
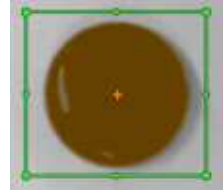
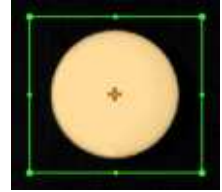
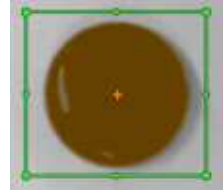
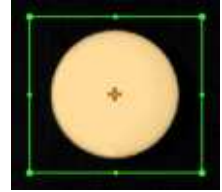
No.	Item	Description									
1	Pass range	<p>It sets the pass/fail range of area.</p>  <p>Lower limit for pass Measured ROI area value Upper limit for pass</p>									
2	Binary threshold	<p>It sets the threshold value to detect area. It is to process inspection with the binary coded threshold value. After converting each pixel of the image under the threshold value to 0 and each pixel of the image over the threshold value to 1, 0 passes the area inspection, while 1 fails to pass the area inspection.</p>									
3	Extraction mode	<p>It sets method of detecting area.</p> <table border="1"> <tr> <td>Item</td> <td>Dark object on the bright background</td> <td>Bright object on the dark background</td> </tr> <tr> <td>Description</td> <td>Extracting darker area compared to the brightness standard</td> <td>Extracting brighter area compared to the brightness standard</td> </tr> <tr> <td>Image</td> <td></td> <td></td> </tr> </table>	Item	Dark object on the bright background	Bright object on the dark background	Description	Extracting darker area compared to the brightness standard	Extracting brighter area compared to the brightness standard	Image		
Item	Dark object on the bright background	Bright object on the dark background									
Description	Extracting darker area compared to the brightness standard	Extracting brighter area compared to the brightness standard									
Image											

No.	Item	Description
4	Automatic teaching	Even if user set the pass range, it teaches pass range based on the pixel of ROI.
5	ROI type	It sets type of ROI to inspect. <input type="checkbox"/> RECTANGLE <input checked="" type="checkbox"/> POLYGON <input type="checkbox"/> CIRCLE (rectangle/polygon/circle)
6	OK/Cancel	It registers work to work group or cancel to register.

※Threshold is the boundary value when a value is discontinuously changed.



Ex.

Examples of pass/fail in the area inspection

- Registering template of the inspection target (area: 13229 / pass range: 11244 to 15213)

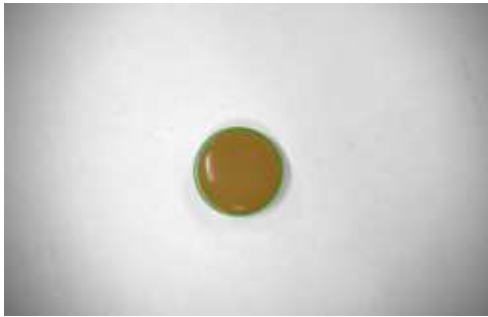

- Passed area inspection



- Failed area inspection





6.7.5 Edge

You can use the edge function to inspect the presence of the edge.

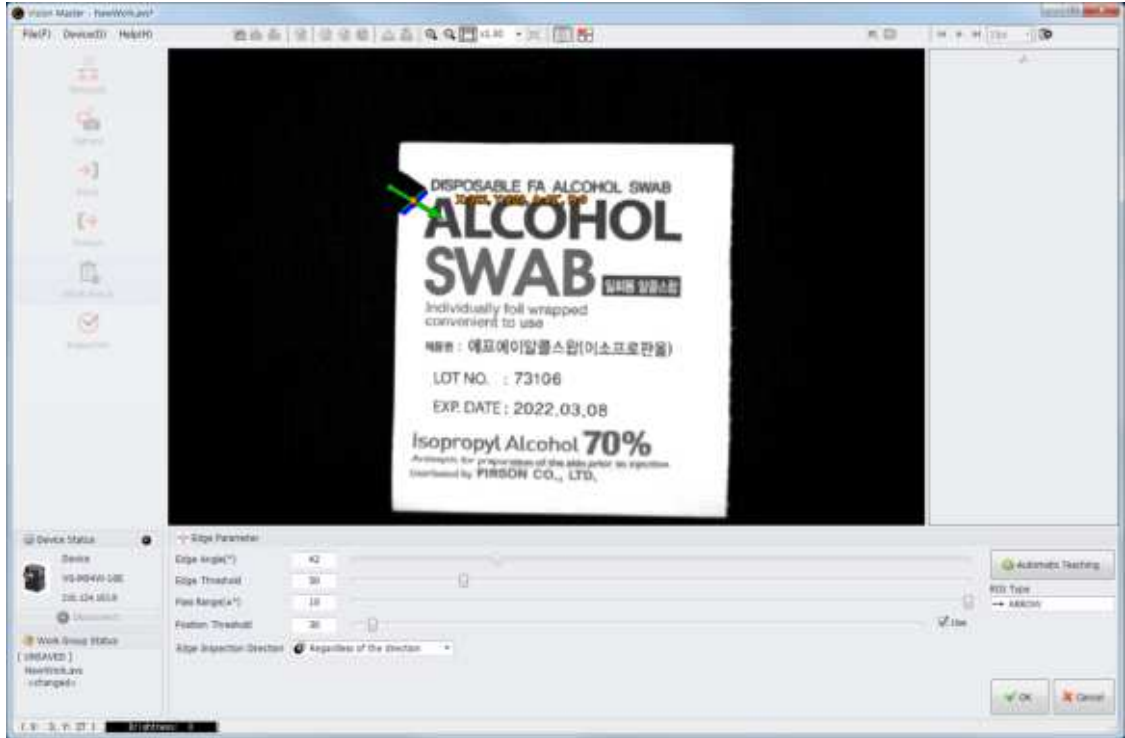
Edge compares directions of the registered edge and edges in the same area of the input image to detect the presence of the edge. It sets the pass range based on the direction of the registered edge. The edge of the inspection target in the pass range is regarded as Pass, while the edge of the inspection target out of the pass range is regarded as Fail.

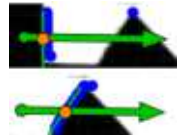
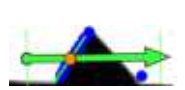
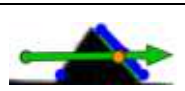
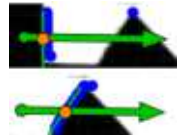
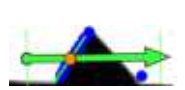
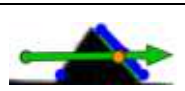
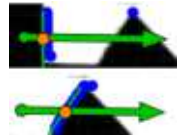
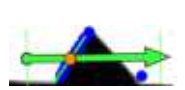
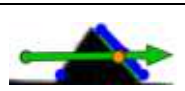

No.	Item	Description
1	Edge angle(°)	It is the measured angle value of edge grade. 
2	Edge threshold	It sets threshold to detect edge. Only edges with high contrast can be detected in high edge threshold, while edges with low contrast also can be detected in low edge threshold.
3	Pass range(±°)	It sets the pass/fail range of edge. Setting range: ±0 to ±10°
4	Position threshold	It is range of the distance between edge at ROI teaching and edge detected from inspection target. If the distance between edge at ROI teaching (0) and edge detected from inspection target is within the range of position threshold, it is processed as pass.

No.	Item	Description												
5	Edge Inspection Direction	It sets method for inspecting edge. It searches edge along the direction of arrow in the ROI.												
		<table border="1"> <thead> <tr> <th>Item</th> <th>Description</th> <th>Image</th> </tr> </thead> <tbody> <tr> <td>Regardless of the direction</td> <td>Detects firstly encountering edge in the ROI range.</td> <td></td> </tr> <tr> <td>Bright area → Dark area</td> <td>Detects edge on the boundary line from bright area to dark area.</td> <td></td> </tr> <tr> <td>Dark area → Bright area</td> <td>Detects edge on the boundary line from dark area to bright area.</td> <td></td> </tr> </tbody> </table>	Item	Description	Image	Regardless of the direction	Detects firstly encountering edge in the ROI range.		Bright area → Dark area	Detects edge on the boundary line from bright area to dark area.		Dark area → Bright area	Detects edge on the boundary line from dark area to bright area.	
		Item	Description	Image										
		Regardless of the direction	Detects firstly encountering edge in the ROI range.											
		Bright area → Dark area	Detects edge on the boundary line from bright area to dark area.											
Dark area → Bright area	Detects edge on the boundary line from dark area to bright area.													
Automatic teaching	When user changes parameter or adjust ROI, it teaches automatically.													
7	ROI type	<p>It sets type of ROI to inspect.</p> <p> (arrow)</p> <p>X, Y axes coordinate of the edge (A) and distance from the edge (D) are displayed.</p> 												
8	OK/Cancel	It registers work to work group or cancel to register.												

※Threshold is the boundary value when a value is discontinuously changed.



Ex.

Examples of pass/fail in the edge inspection

- Registering template of the inspection target (edge angle: 42° / pass range: $\pm 10^\circ$)



- Passed edge (alignment applied)



- Failed edge



6.7.6 Shape comparison

You can use the shape comparison function to inspect the shape of the object.

Shape comparison compares features and patterns of the target object in the ROI of the input image and that of the registered image.

It sets pass range based on the similarity of the ROI in the registered image and the ROI in the input image.

Similarity of the two images over the threshold is regarded as Pass, while similarity of the two images under the threshold is regarded as Fail.

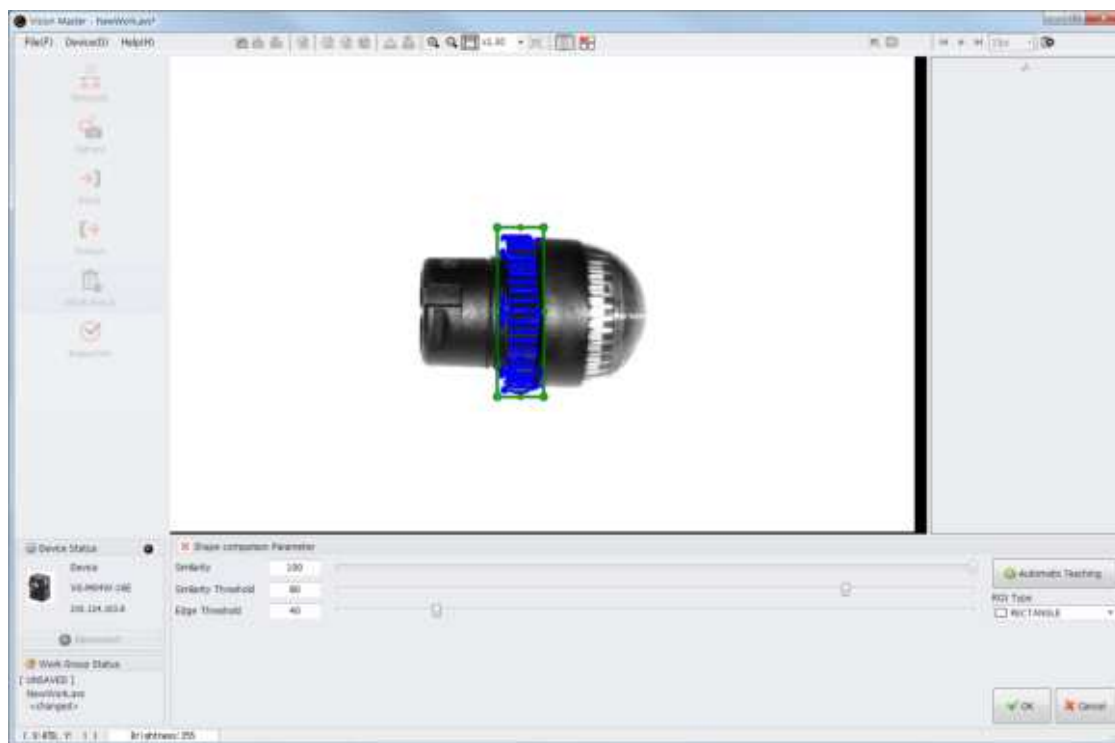

No.	Item	Description
1	Similarity	It is similarity of the registered template and the detected template.
2	Similarity threshold ^{※1}	It is similarity discrimination value for determining pass/fail.
3	Edge threshold	It sets threshold to detect edge. Only edges with high contrast can be detected in high edge threshold, while edges with low contrast also can be detected in low edge threshold.
4	Automatic teaching	Even if user set the pass range, it teaches pass range based on the pixel of ROI.
5	ROI type	It sets type of ROI to inspect. <input type="checkbox"/> RECTANGLE <input type="checkbox"/> POLYGON <input type="checkbox"/> CIRCLE (rectangle/polygon/circle)
6	OK/Cancel	It registers work to work group or cancel to register.

※Threshold is the boundary value when a value is discontinuously changed.

※1. When set template of ROI is 50% similar with the input image in 50 similarity threshold, the vision sensor regards them as the same target and outputs output signal.

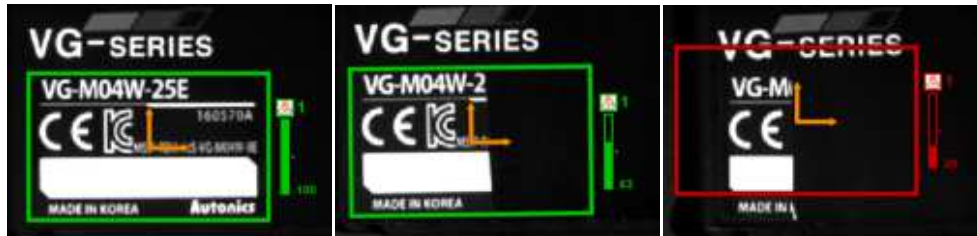

Ex.

Examples of pass/fail in the shape comparison inspection

- Registering template of the inspection target (Similarity: 100% / Similarity threshold: 80%)

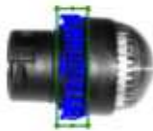

- Passed shape comparison inspection (alignment applied)

PASS

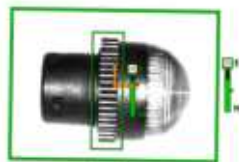

- Failed shape comparison inspection

FAIL





6.7.7 Length

You can use the length function to inspect the length between two edges. The length unit is pixel.

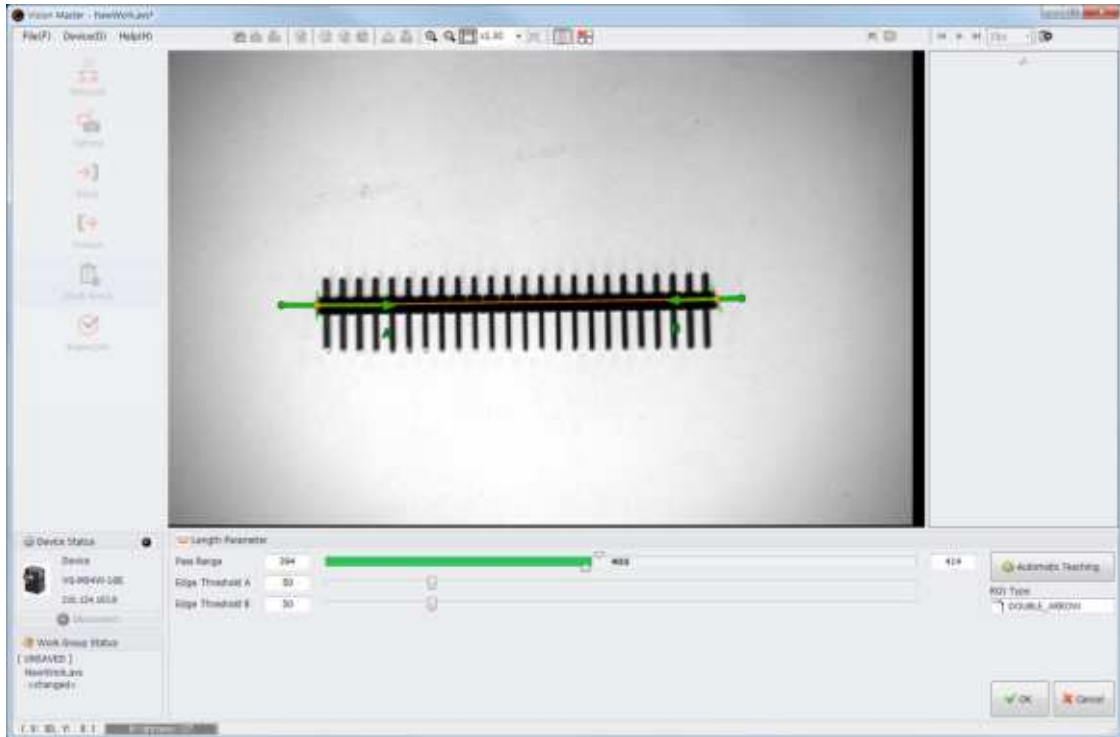
Base points of measuring length are two edges on each of two arrows. Length sets the pass range based on the length between two registered edges. The measured length of the inspection target within the pass range is regarded as Pass, while the measured length of the inspection target out of the pass range is regarded as Fail.

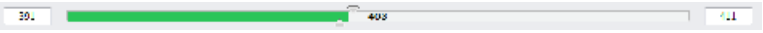

No.	Item	Description
1	Pass range	<p>It sets the pass/fail range of length.</p>  <p>Lower limit for pass Measured ROI length value Upper limit for pass</p>
2	Edge threshold A/B	<p>It sets threshold to detect edge.</p> <p>Only edges with high contrast can be detected in high edge threshold, while edges with low contrast also can be detected in low edge threshold.</p>
3	Automatic teaching	<p>Even if user set the pass range, it teaches pass range based on the pixel of ROI.</p>
4	ROI type	<p>It sets type of ROI to inspect.</p> <p>In the ROI area, the program scans the edge in the arrow direction and firstly detected edge becomes standard for inspection.</p>  <p>(two arrows)</p>
5	OK/Cancel	<p>It registers work to work group or cancel to register.</p>

※Threshold is the boundary value when a value is discontinuously changed.

**Ex.**

Examples of pass/fail in the length inspection

- Registering template of the inspection target (Length: 386 / pass range: 376 to 396)



- Passed length inspection (alignment applied)

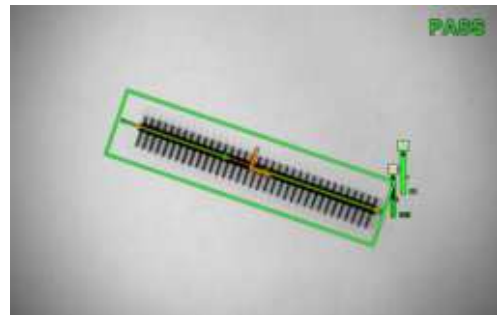
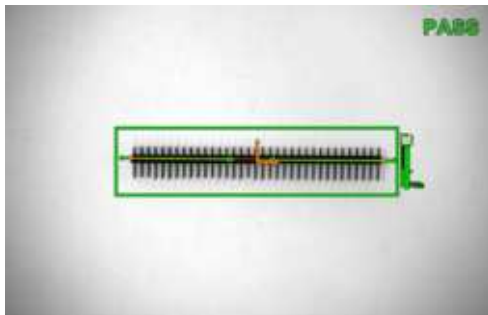

- Failed length inspection

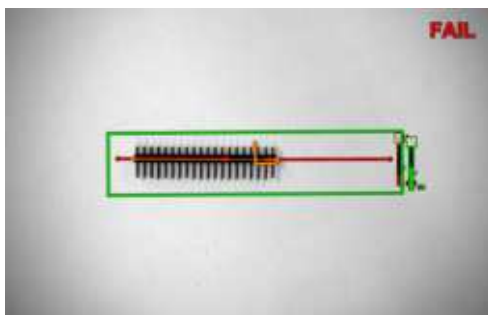

6.7.8 Angle

You can use the angle function to inspect the angle between two edges. The unit of angle is $^{\circ}$ (degree).

Angle measures angle of crossing point which is between two edges of registered arrows.

It sets the pass range based on the angle between two registered edges. The measured angle of the inspection target within the pass range is regarded as Pass, while the measured angle of the inspection target out of the pass range is regarded as Fail.

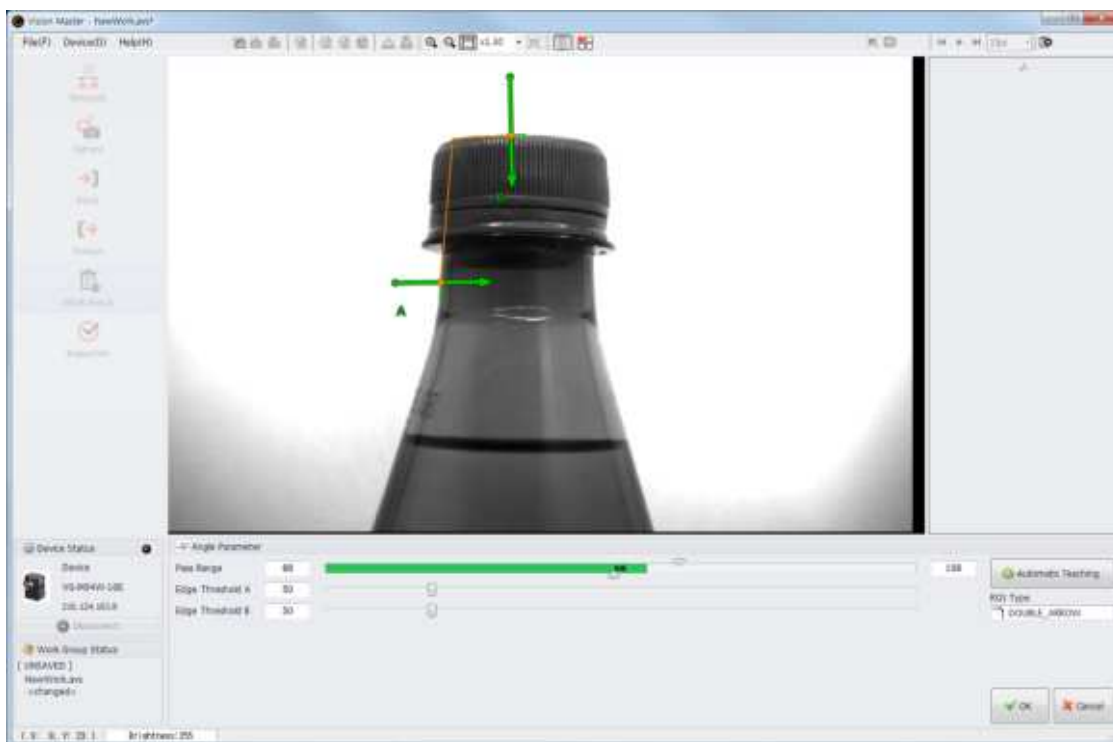

No.	Item	Description
1	Pass range	<p>It sets the pass/fail range of angle.</p> <p>Lower limit for pass Measured ROI angle value Upper limit for pass</p>
2	Edge threshold A/B	<p>It sets threshold to detect edge.</p> <p>Only edges with high contrast can be detected in high edge threshold, while edges with low contrast also can be detected in low edge threshold.</p>
3	Automatic teaching	<p>Even if user set the pass range, it teaches pass range based on the pixel of ROI.</p>
4	ROI type	<p>It sets type of ROI to inspect.</p> <p>In the ROI area, the program scans the edge in the arrow direction and firstly detected edge becomes standard for inspection.</p> <p><input type="text" value="DOUBLE_ARROW"/> (two arrows)</p>
5	OK/Cancel	<p>It registers work to work group or cancel to register.</p>

※Threshold is the boundary value when a value is discontinuously changed.

**Ex.**

Examples of pass/fail in the angle inspection

- Registering template of the inspection target (angle: 98° / pass range: 88 to 108°)



- Passed angle inspection



- Failed angle inspection





6.7.9 Diameter

You can use the diameter function to inspect diameter of the circle. The unit of diameter is pixel.

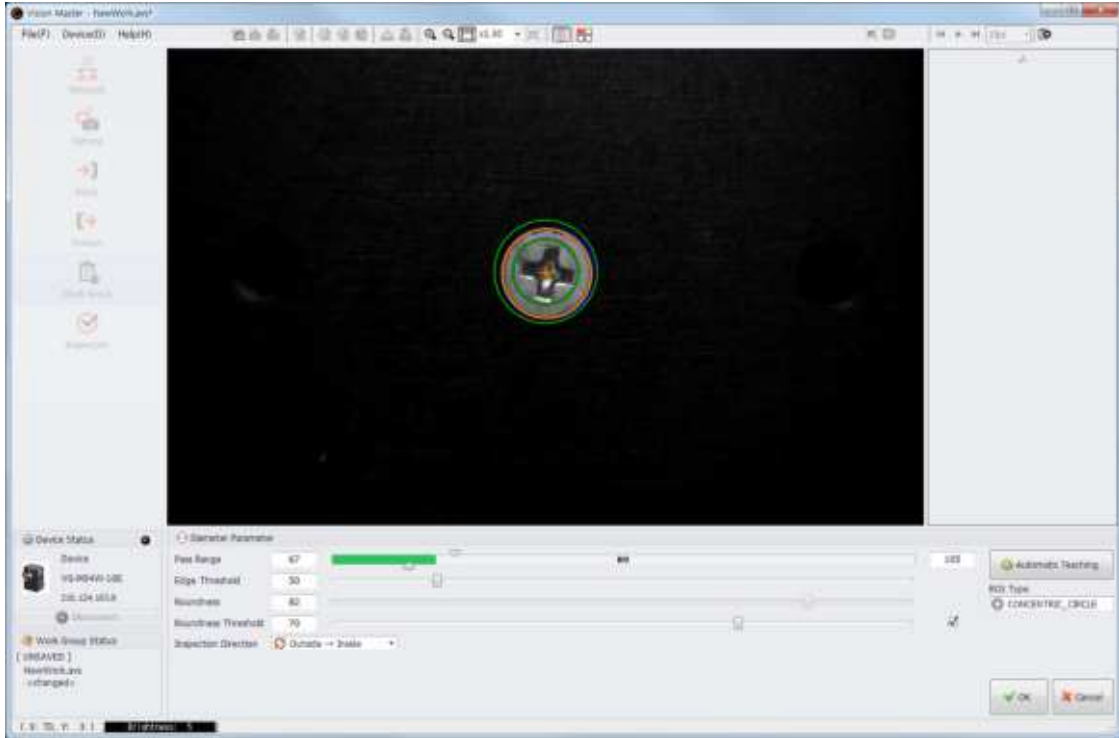
Diameter detects circle in the registered area which is between two circles (minimum and maximum diameter of the circle). The detected diameter within the minimum/maximum area is regarded as Pass, while the detected diameter out of the minimum/maximum area is regarded as Fail.

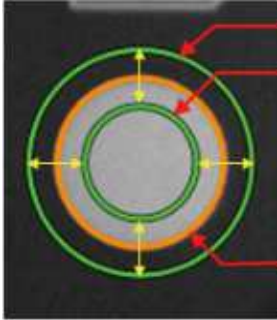
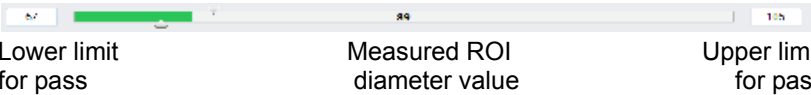

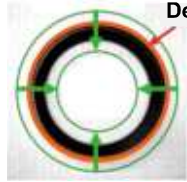
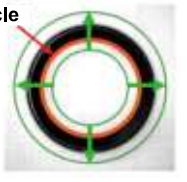
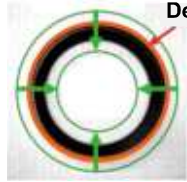
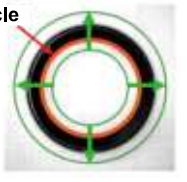
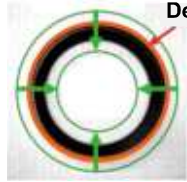
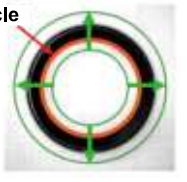
No.	Item	Description
1	Pass range	 <p>It sets pass/fail range of circle.</p> 
2	Edge threshold	It sets threshold to detect edge. Only edges with high contrast can be detected in high edge threshold, while edges with low contrast also can be detected in low edge threshold.
3	Roundness	It is roundness of the detected circle.
4	Roundness threshold ^{*1}	It sets threshold to detect circle. It inspects diameter of the circle which of roundness is over the threshold. <input checked="" type="checkbox"/> checks whether to use roundness threshold or not.

No.	Item	Description									
5	Inspection direction	It sets method to detect circle. When you setting ROI, two circles are made and area between two circles is the range to detect circle.									
		<table border="1"> <thead> <tr> <th>Item</th> <th>Outside→Inside</th> <th>Inside→Outside</th> </tr> </thead> <tbody> <tr> <td>Description</td> <td>Scanning the pass area from outside to inside. Detecting outermost circle in multiple circles.</td> <td>Scanning the pass area from inside to outside. Detecting innermost circle in multiple circles.</td> </tr> <tr> <td>Image</td> <td>  </td> <td>  </td> </tr> </tbody> </table>	Item	Outside→Inside	Inside→Outside	Description	Scanning the pass area from outside to inside. Detecting outermost circle in multiple circles.	Scanning the pass area from inside to outside. Detecting innermost circle in multiple circles.	Image		
		Item	Outside→Inside	Inside→Outside							
Description	Scanning the pass area from outside to inside. Detecting outermost circle in multiple circles.	Scanning the pass area from inside to outside. Detecting innermost circle in multiple circles.									
Image											
6	Automatic teaching	When user changes parameter or adjust ROI, it teaches automatically.									
7	ROI type	It sets type of ROI to inspect.  (concentric circle)									
8	OK/Cancel	It registers work to work group or cancel to register.									

※Threshold is the boundary value when a value is discontinuously changed.

※1. When roundness threshold is set to 50, an object with 50% of circle shape is regarded as circle.

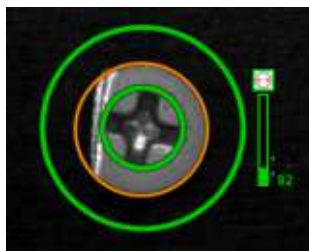

**Ex.**

Examples of pass/fail in the diameter inspection

- Registering template of the inspection target (diameter: 92, / pass range: 75 to 111)



- Passed diameter inspection

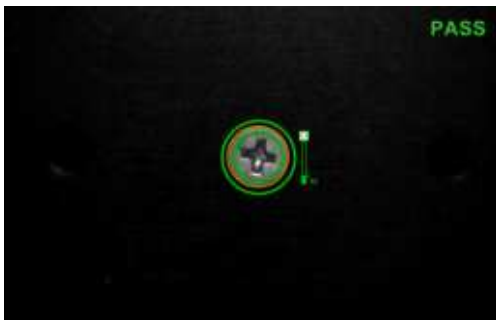

- Failed diameter inspection

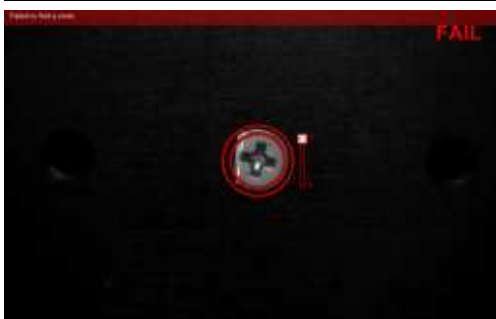
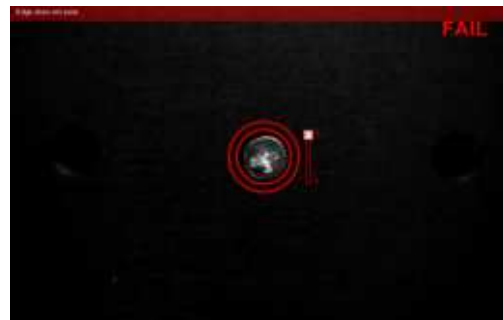
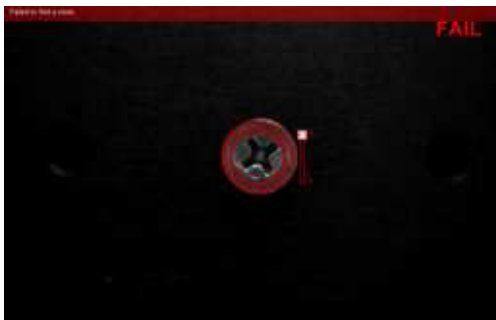

6.7.10 Object counting

You can use the object counting function to count the number of object.

Object counting counts the number of object in the registered ROI. It regards object with the certain amount of pixel as an object, and compares the number of detected object. The number of detected object within the pass range is regarded as Pass, while the number of detected object out of the pass range is regarded as Fail.

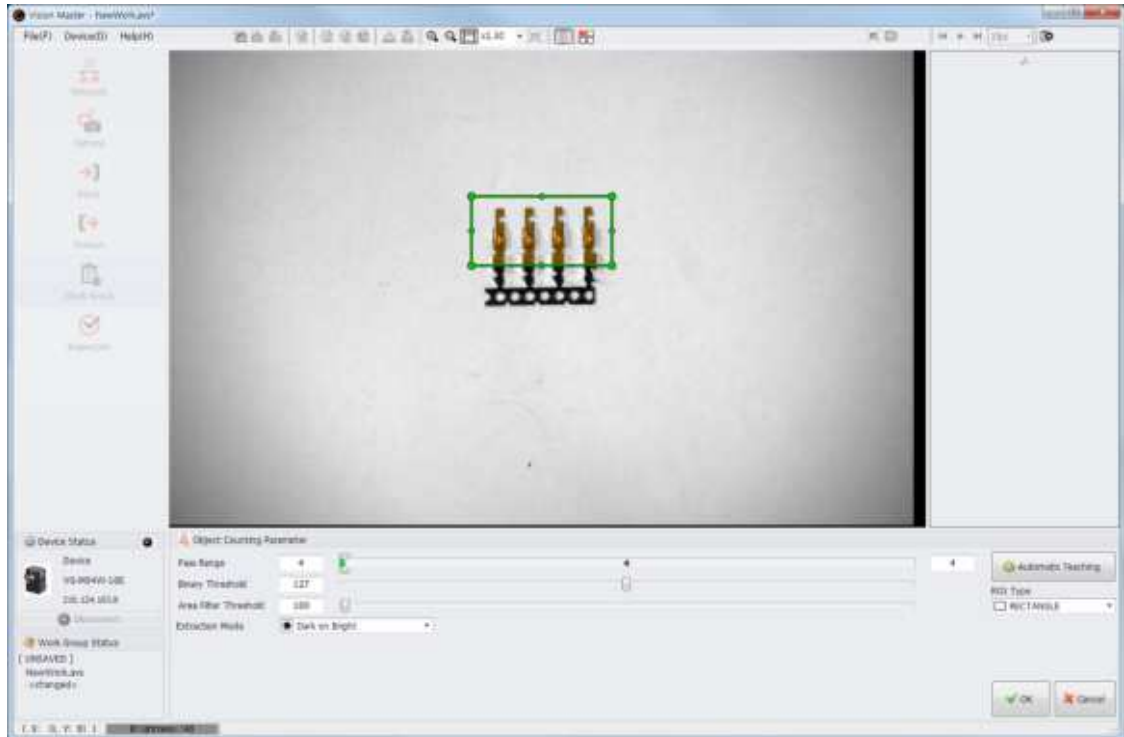

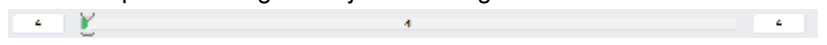
No.	Item	Description
1	Pass range	<p>It sets the pass/fail range of object counting.</p>  <p>Lower limit for pass The measured number of ROI object Upper limit for pass</p>
2	Binary threshold	<p>It sets the threshold value to detect area. Binary threshold means processing inspection with the binary coded threshold value. After converting each pixel of the image under the threshold value to 0 and each pixel of the image over the threshold value to 1, 0 passes the area inspection, while 1 fails to pass the area inspection.</p>
3	Area filter threshold	<p>It sets the standard value for regarding as an area. Area filter threshold regards a group of objects with the number of pixels over the binary threshold as an area.</p>

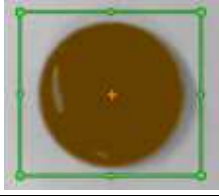
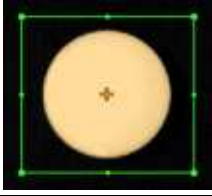
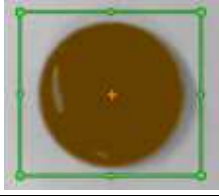
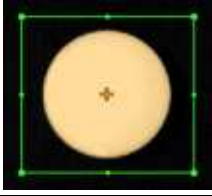
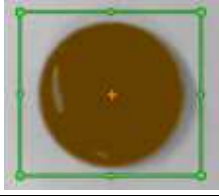
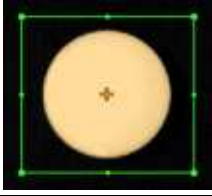
No.	Item	Description									
4	Extraction mode	It sets method of detecting area.									
		<table border="1"> <tr> <td>Item</td> <td>Dark object on the bright background</td> <td>Bright object on the dark background</td> </tr> <tr> <td>Description</td> <td>Extracting darker area compared to the brightness standard</td> <td>Extracting brighter area compared to the brightness standard</td> </tr> <tr> <td>Image</td> <td></td> <td></td> </tr> </table>	Item	Dark object on the bright background	Bright object on the dark background	Description	Extracting darker area compared to the brightness standard	Extracting brighter area compared to the brightness standard	Image		
		Item	Dark object on the bright background	Bright object on the dark background							
Description	Extracting darker area compared to the brightness standard	Extracting brighter area compared to the brightness standard									
Image											
5	Automatic teaching	When user changes parameter or adjust ROI, it teaches automatically.									
6	ROI type	<p>It sets type of ROI to inspect.</p> <div style="border: 1px solid gray; padding: 5px; display: inline-block;"> <input type="checkbox"/> RECTANGLE <input checked="" type="checkbox"/> POLYGON <input type="checkbox"/> CIRCLE </div> <p>(rectangle/polygon/circle)</p>									
7	OK/Cancel	It registers work to work group or cancel to register.									

※Threshold is the boundary value when a value is discontinuously changed.

**Ex.**

Examples of pass/fail in the object counting inspection

- Registering template of the inspection target (the number of object: 4 / pass range: 4)



- Passed object counting (alignment applied)

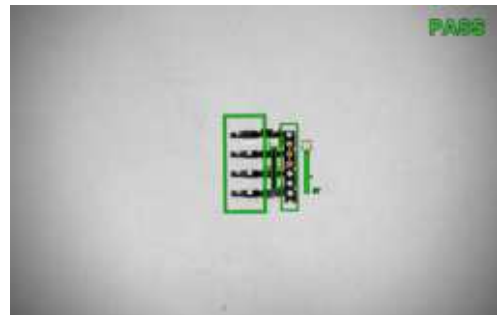

- Failed object counting

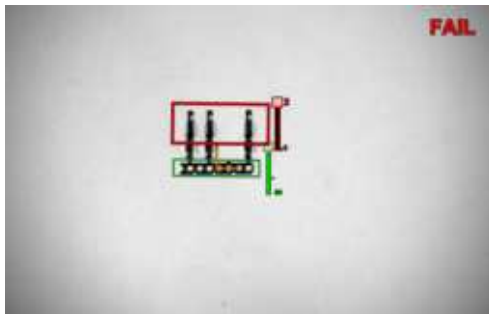

6.7.11 Color identification

You can use the color identification function to inspect object by its color.

Color identification compares ROI average color of registered by user and that of the input image.

Based on the average color value of registered ROI, extracted color from the input image within the color value deviation is regarded as Pass, while extracted color from the input image out of the color value deviation is regarded as Fail.

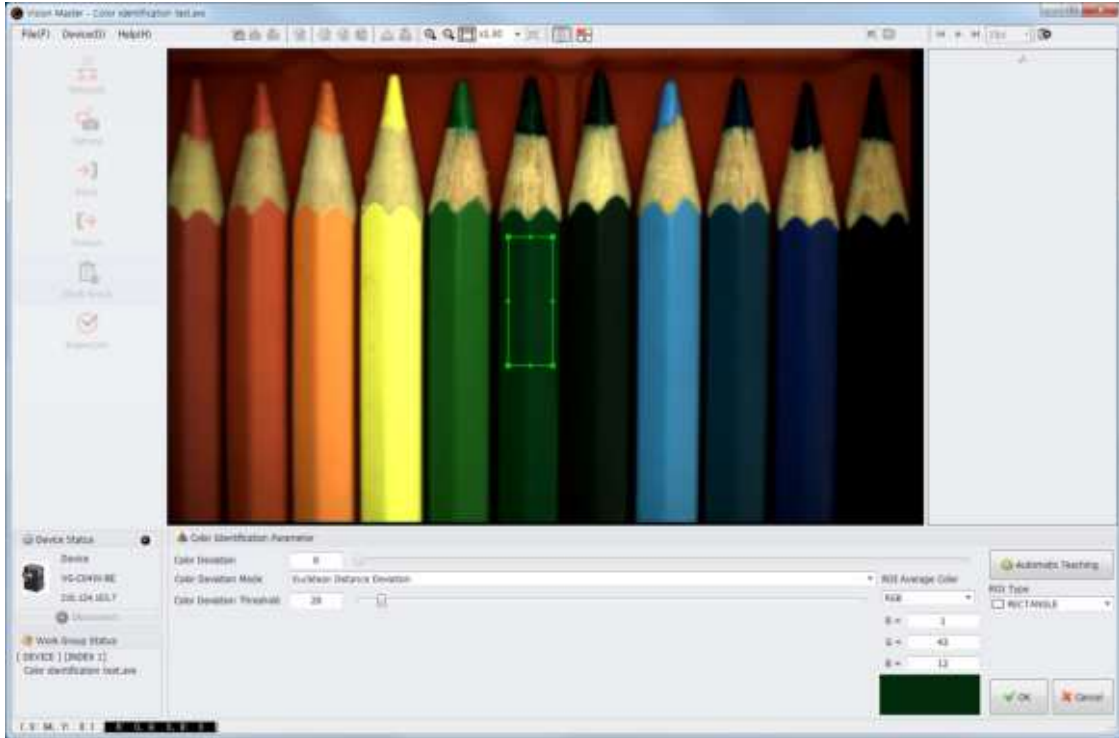

No.	Item	Description	
1	Color deviation	It is color deviation value in ROI.	
2	Color deviation mode ^{*1}	It sets mode to measure color deviation. Color deviation mode is calculating method of pass range for the input image based on the registered ROI average color value. Depending on the color deviation mode, specific setting is different.	
3	Color deviation mode - specific setting	Euclidean distance deviation	Manhattan distance deviation
		Color deviation threshold: It sets pass range based on the ROI average color.	Red/Green/Blue: It sets pass range by applying deviation value to each of red, green, blue color.
4	ROI average color	It displays average color of ROI in a data value, depends on the set color system (color area) mode.	
		<div style="border: 1px solid gray; padding: 2px; display: inline-block;"> RGB CIELab HSV </div> (RGB/CIElab/HSV)	
		Item	Description
	RGB	R (Red) / G (Green) / B (Blue)	
	CIELab	L: contrast (+white ↔ -black) a: Saturation (+red ↔ -green) b: Saturation (+yellow ↔ -blue)	

No.	Item	Description						
		<table border="1"> <tr> <td>HSV</td> <td>H (Hue) / S (Saturation) / V (Value, contrast)</td> </tr> </table> <p>CIELab and HSV are processed in RGB data.</p>	HSV	H (Hue) / S (Saturation) / V (Value, contrast)				
HSV	H (Hue) / S (Saturation) / V (Value, contrast)							
5	Automatic teaching	It teaches color automatically, based on the ROI registered by user. Based on color deviation which is set to "0" automatically, vision master inspects color of the input image.						
6	ROI type	<p>It sets type of ROI to inspect.</p> <table border="1"> <tr> <td><input type="checkbox"/></td> <td>RECTANGLE</td> </tr> <tr> <td><input type="checkbox"/></td> <td>POLYGON</td> </tr> <tr> <td><input type="checkbox"/></td> <td>CIRCLE</td> </tr> </table> <p>(rectangle/polygon/circle)</p>	<input type="checkbox"/>	RECTANGLE	<input type="checkbox"/>	POLYGON	<input type="checkbox"/>	CIRCLE
<input type="checkbox"/>	RECTANGLE							
<input type="checkbox"/>	POLYGON							
<input type="checkbox"/>	CIRCLE							
7	OK/Cancel	It registers work to work group or cancel to register.						

※Threshold is the boundary value when a value is discontinuously changed.

※1: Color Deviation Mode

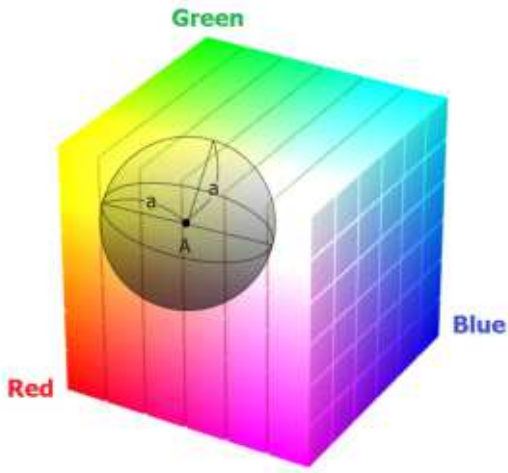
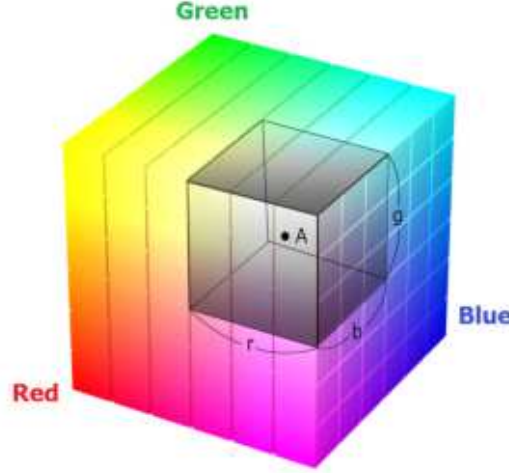
Euclidean distance deviation	Manhattan distance deviation
	
<p>A: Average color value of ROI a: Color deviation threshold Color within the deviation range which is from "A" to "a" is regarded as Pass.</p>	<p>A: Average color value of ROI r: Pass range for red g: Pass range for green b: Pass range for blue Color within the deviation range from "A" to setting value of each color is regarded as Pass.</p>

**Ex.**

Examples of pass/fail in the color identification inspection

- Registering template of the inspection target

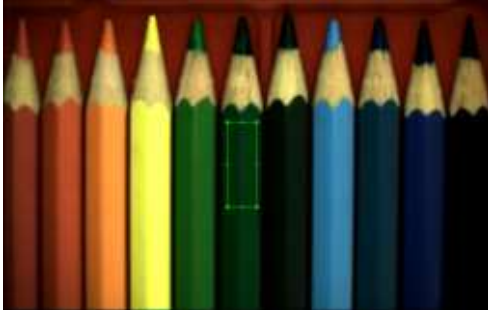

- Passed color identification

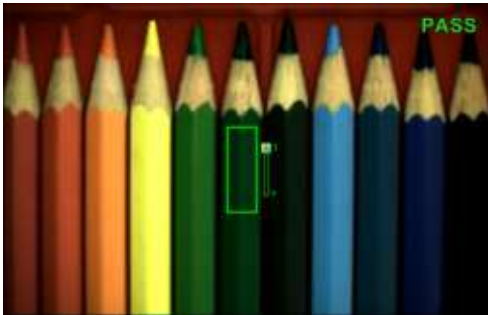

- Failed color identification





6.7.12 Area of color

You can use the area of color function to inspect area of a certain color. Area means the number of pixels in a certain color.

Area of color measures area of a certain color (the number of pixel) in the ROI area of the input image.

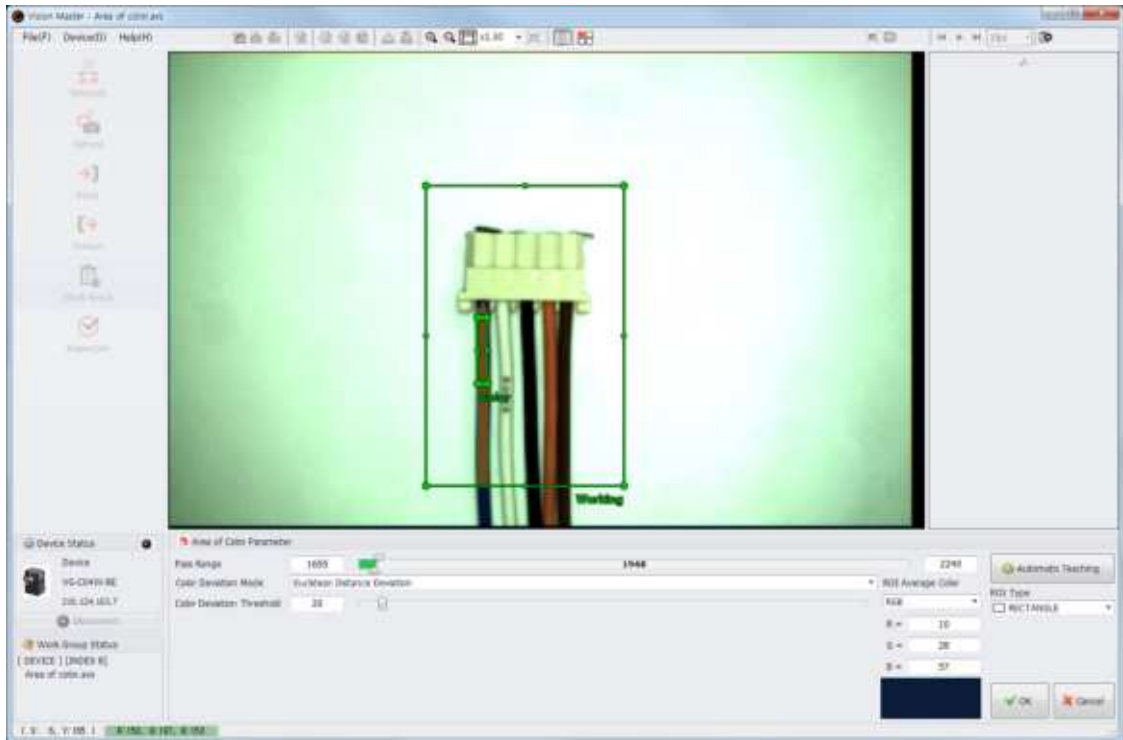
Detected area of the color (the number of pixel) from the input image within the pass range is regarded as Pass, while detected area of the color (the number of pixel) from the input image out of the pass range is regarded as Fail.

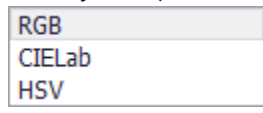

No.	Item	Description	
1	Pass range	It sets the pass/fail range for inspecting the teaching color (Color) in the ROI area (Working). 	
2	Color deviation mode ^{*1}	It sets mode to measure color deviation. Color deviation mode is calculating method of pass range for the input image based on the registered ROI average color value. Depending on the color deviation mode, specific setting is different.	
3	Color deviation mode - specific setting	Euclidean distance deviation	Manhattan distance deviation
		Color deviation threshold: It sets pass range based on the ROI average color.	Red/Green/Blue: It sets pass range by applying deviation value to each of red, green, blue color.
4	ROI average color	It displays average color of ROI in a data value, depends on the set color system (color area) mode.  (RGB/CIElab/HSV)	
		Item	Description

No.	Item	Description								
		<table border="1"> <tr> <td>RGB</td> <td>R (Red) / G (Green) / B (Blue)</td> </tr> <tr> <td rowspan="3">CIELab</td> <td>L: contrast (+white ↔ -black)</td> </tr> <tr> <td>a: Saturation (+red ↔ -green)</td> </tr> <tr> <td>b: Saturation (+yellow ↔ -blue)</td> </tr> <tr> <td>HSV</td> <td>H (Hue) / S (Saturation) / V (Value, contrast)</td> </tr> </table> <p>CIELab and HSV are processed in RGB data.</p>	RGB	R (Red) / G (Green) / B (Blue)	CIELab	L: contrast (+white ↔ -black)	a: Saturation (+red ↔ -green)	b: Saturation (+yellow ↔ -blue)	HSV	H (Hue) / S (Saturation) / V (Value, contrast)
RGB	R (Red) / G (Green) / B (Blue)									
CIELab	L: contrast (+white ↔ -black)									
	a: Saturation (+red ↔ -green)									
	b: Saturation (+yellow ↔ -blue)									
HSV	H (Hue) / S (Saturation) / V (Value, contrast)									
5	Automatic teaching	It teaches color automatically, based on the ROI registered by user. Based on color deviation which is set to "0" automatically, vision master inspects color of the input image.								
6	ROI type	It sets type of ROI to inspect. <table border="1"> <tr> <td><input type="checkbox"/></td> <td>RECTANGLE</td> </tr> <tr> <td><input type="checkbox"/></td> <td>POLYGON</td> </tr> <tr> <td><input type="checkbox"/></td> <td>CIRCLE</td> </tr> </table> (rectangle/polygon/circle)	<input type="checkbox"/>	RECTANGLE	<input type="checkbox"/>	POLYGON	<input type="checkbox"/>	CIRCLE		
<input type="checkbox"/>	RECTANGLE									
<input type="checkbox"/>	POLYGON									
<input type="checkbox"/>	CIRCLE									
7	OK/Cancel	It registers work to work group or cancel to register.								

※Threshold is the boundary value when a value is discontinuously changed.

※1: Color Deviation Mode

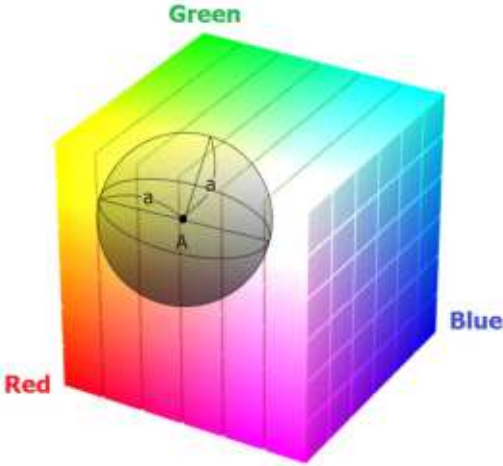
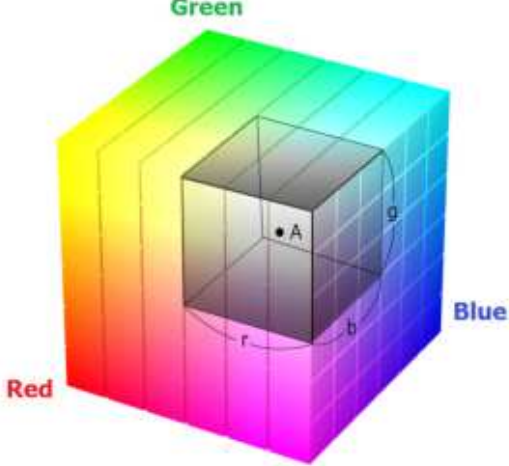
Euclidean distance deviation	Manhattan distance deviation
	
<p>A: Average color value of ROI a: Color deviation threshold Color within the deviation range which is from "A" to "a" is regarded as Pass.</p>	<p>A: Average color value of ROI r: Pass range for red g: Pass range for green b: Pass range for blue Color within the deviation range from "A" to setting value of each color is regarded as Pass.</p>

**Ex.**

Examples of pass/fail in the area of color inspection

- Registering template of the inspection target
(area of color: 1948 / pass range: 1655 to 2240)

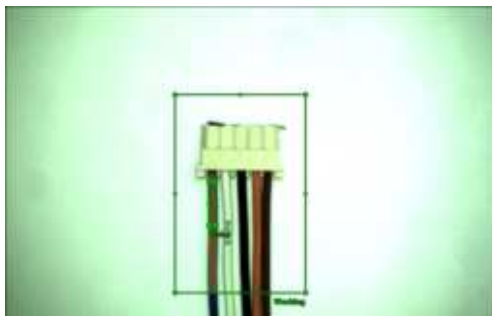

- Passed area of color

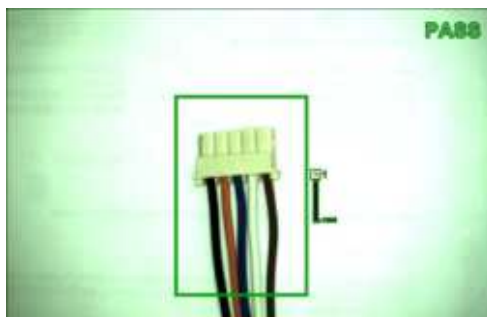
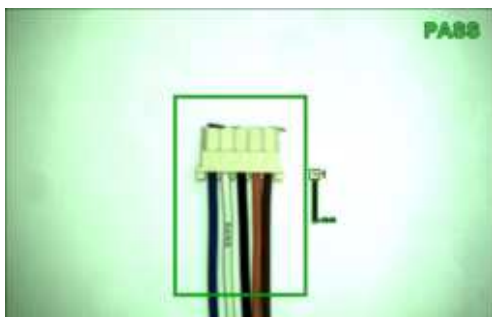

- Failed area of color

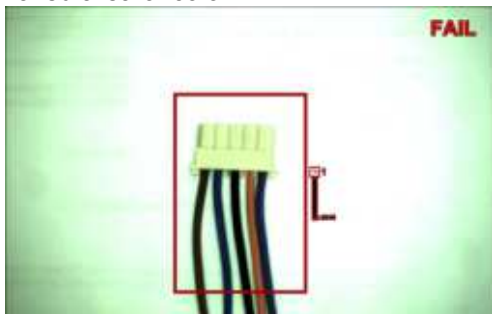

6.7.13 Object of color counting

You can use the object of color counting function to count the number of object in a certain color. Area means the number of pixels in a certain color.

User designates color to inspect from the target, and registers area to be inspected. Object of color counting inspects the number of object in a certain color in the registered ROI. It regards object with the certain amount of pixel as an object, and compares the number of detected object. The number of detected object within the pass range is regarded as Pass, while the number of detected object out of the pass range is regarded as Fail.



No.	Item	Description	
1	Pass range	It sets the pass/fail range for inspecting the teaching color (Color) in the ROI area (Working). <div style="border: 1px solid gray; padding: 2px; width: fit-content; margin: 5px 0;"> <input type="text" value="10"/> </div> Lower limit for pass The measured number of object of color in ROI Upper limit for pass	
2	Color deviation mode ^{*1}	It sets mode to measure color deviation. Color deviation mode is calculating method of pass range for the input image based on the registered ROI average color value. Depending on the color deviation mode, specific setting is different.	
3	Color deviation mode - specific setting	Euclidean distance deviation	Manhattan distance deviation
		Color deviation threshold: It sets pass range based on the ROI average color.	Red/Green/Blue: It sets pass range by applying deviation value to each of red, green, blue color.
4	ROI average color	It displays average color of ROI in a data value, depends on the set color system (color area) mode. <div style="border: 1px solid gray; padding: 2px; width: fit-content; margin: 5px 0;"> RGB CIElab HSV </div> (RGB/CIElab/HSV)	

No.	Item	Description								
		<table border="1"> <tr> <td>Item</td> <td>Description</td> </tr> <tr> <td>RGB</td> <td>R (Red) / G (Green) / B (Blue)</td> </tr> <tr> <td>CIELab</td> <td>L: contrast (+white ↔ -black) a: Saturation (+red ↔ -green) b: Saturation (+yellow ↔ -blue)</td> </tr> <tr> <td>HSV</td> <td>H (Hue) / S (Saturation) / V (Value, contrast)</td> </tr> </table> <p>CIELab and HSV are processed in RGB data.</p>	Item	Description	RGB	R (Red) / G (Green) / B (Blue)	CIELab	L: contrast (+white ↔ -black) a: Saturation (+red ↔ -green) b: Saturation (+yellow ↔ -blue)	HSV	H (Hue) / S (Saturation) / V (Value, contrast)
Item	Description									
RGB	R (Red) / G (Green) / B (Blue)									
CIELab	L: contrast (+white ↔ -black) a: Saturation (+red ↔ -green) b: Saturation (+yellow ↔ -blue)									
HSV	H (Hue) / S (Saturation) / V (Value, contrast)									
5	Automatic teaching	It teaches color automatically, based on the ROI registered by user. Based on color deviation which is set to "0" automatically, vision master inspects color of the input image.								
6	ROI type	It sets type of ROI to inspect. <div style="border: 1px solid black; padding: 5px; display: inline-block;"> <input type="checkbox"/> RECTANGLE <input type="checkbox"/> POLYGON <input type="checkbox"/> CIRCLE </div> (rectangle/polygon/circle)								
7	OK/Cancel	It registers work to work group or cancel to register.								

※Threshold is the boundary value when a value is discontinuously changed.

※1: Color Deviation Mode

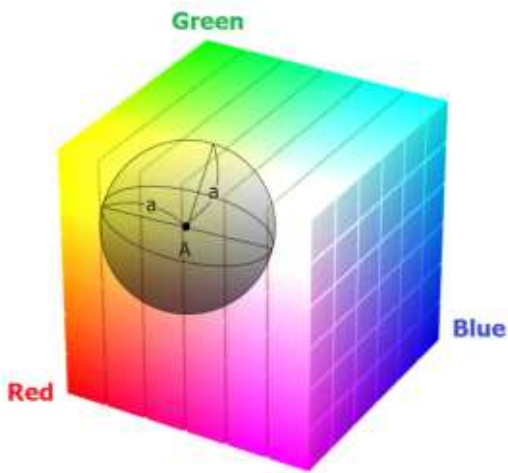
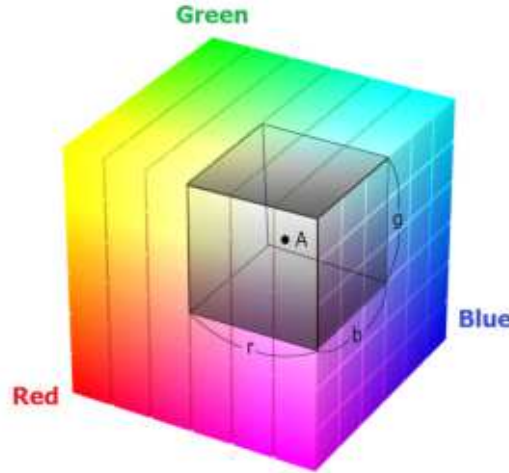
Euclidean distance deviation	Manhattan distance deviation
	
<p>A: Average color value of ROI a: Color deviation threshold Color within the deviation range which is from "A" to "a" is regarded as Pass.</p>	<p>A: Average color value of ROI r: Pass range for red g: Pass range for green b: Pass range for blue Color within the deviation range from "A" to setting value of each color is regarded as Pass.</p>

**Ex.**

Examples of pass/fail in the object of color counting inspection

- Registering template of the inspection target
(the number of object: 10 / pass range: 10)

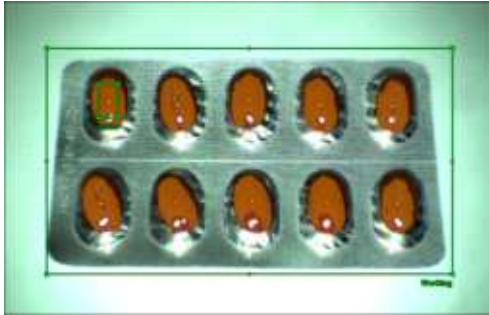

- Passed object of color counting



- Failed object of color counting



7 Settings

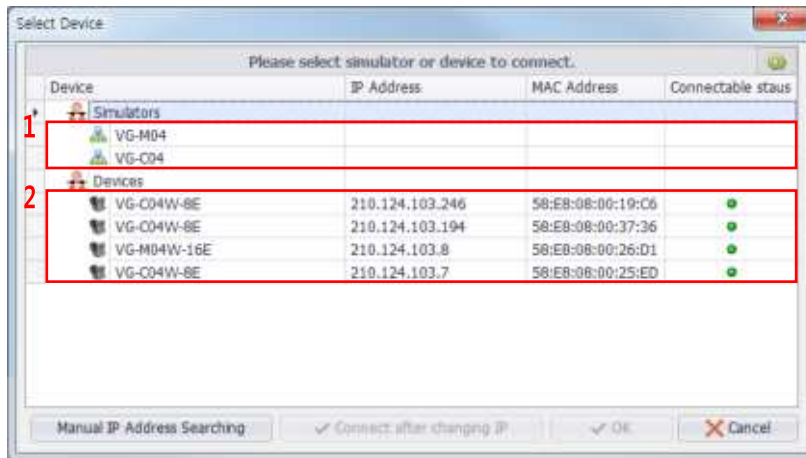

No.	Items	Description
1	Simulator	<p>Without vision sensor, you can register work group using an image saved in the PC for inspection test.</p>
2	Device (Vision sensor)	<p>A list of connected vision sensors is displayed. You can select the vision sensor to use from the list of connected vision sensor. After registering work group and setting parameters, you can start inspection.</p>

7.1 Simulator

1st After installing Vision Master, select the simulator, 'VG-04', in the Select device window. Or, you can check work group and inspection with the simulator.

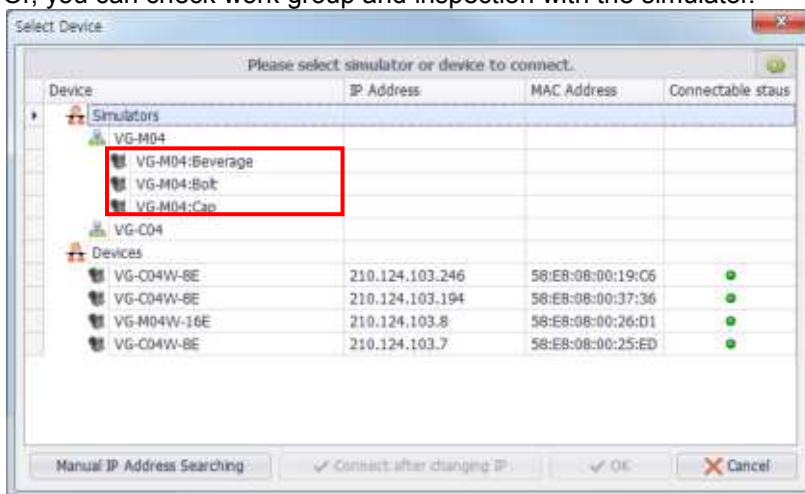

2nd Click 'Open image(O)' or 'Open all images from folder(F)' from the File(F) in the menu to load an image to inspect. You can see the loaded image in the image window and preview window in the right side of the screen.

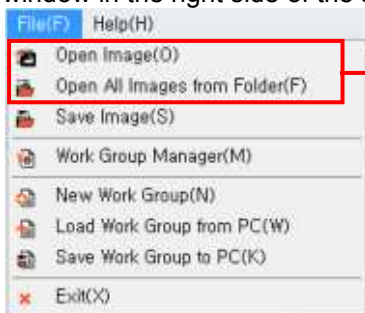

Work group

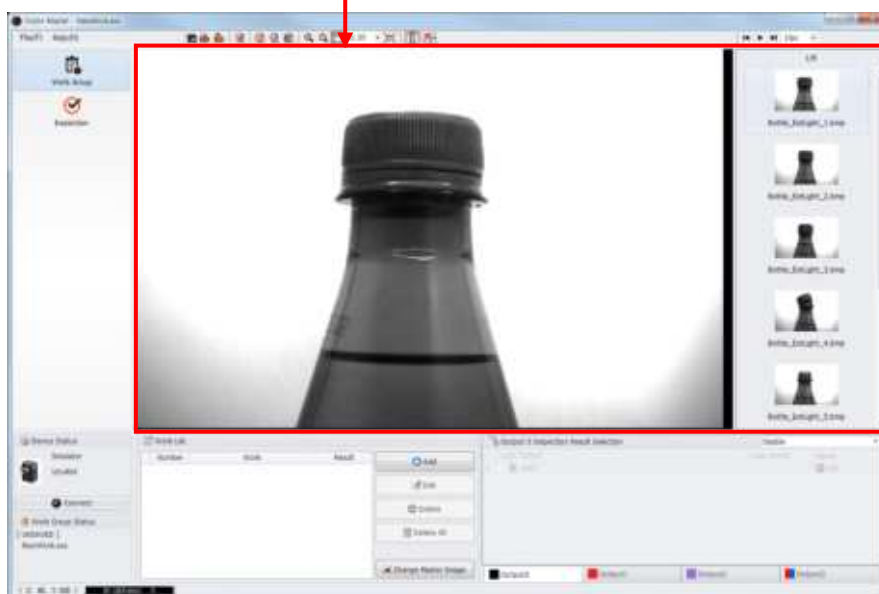

3rd When adding work in the 'work group' setting, click [OK] button in the following pop-up message to register master image. For more details, refer to '6.6.5 Work Group'.

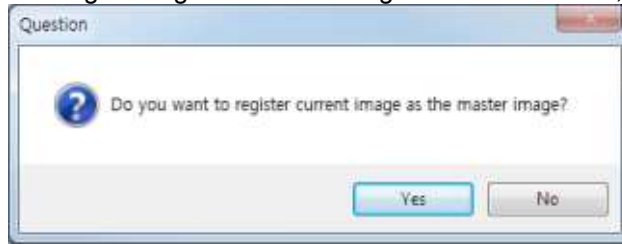

4th Set inspection items. For more details, refer to '6.7 Inspection'.



Work group

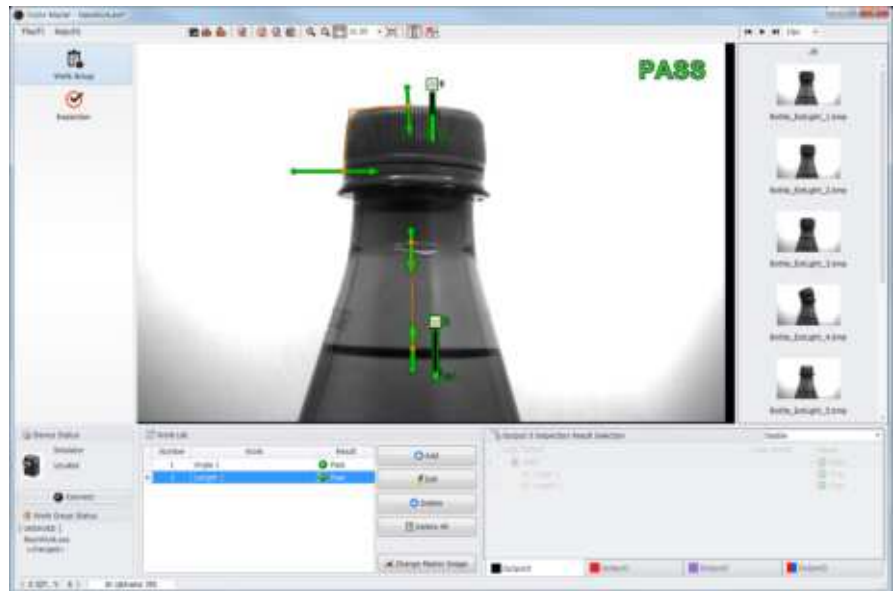

- 5th Click 'Play' icon (▶) on the top right side.
You can see inspection status in the 'Inspection' setting window by playing the images of the preview window.

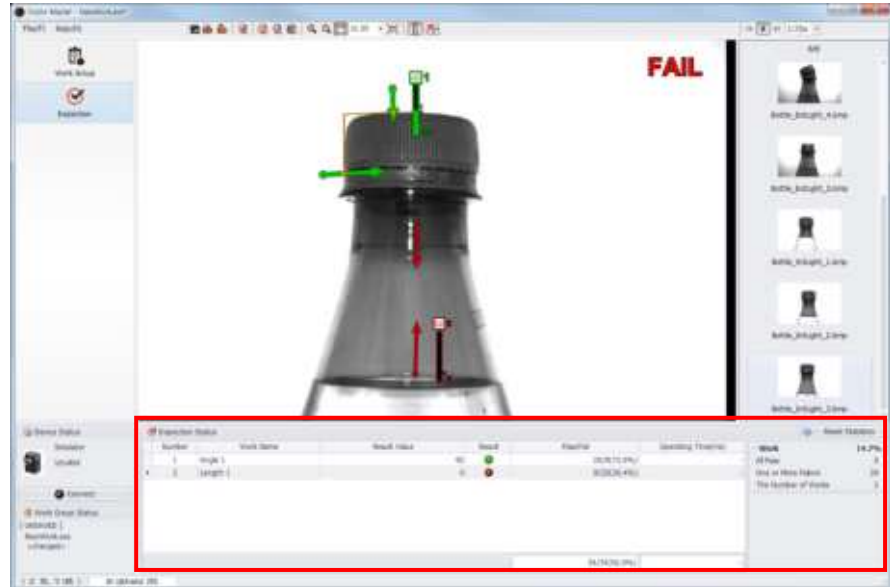

- 6th You can save work group registered with the simulator in the PC.

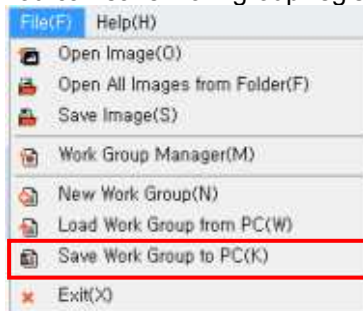

7.2 Device (Vision Sensor)

- 1st After installing Vision Master, select a device vision sensor) to use from a list of connected devices (vision sensor) by checking IP address.
- 2nd Click focusing guide in the 'Camera' setting to set the area to focus on, and adjust focus with focus adjuster. When adjusting focus with focusing guide, run Continuous snap (▶).

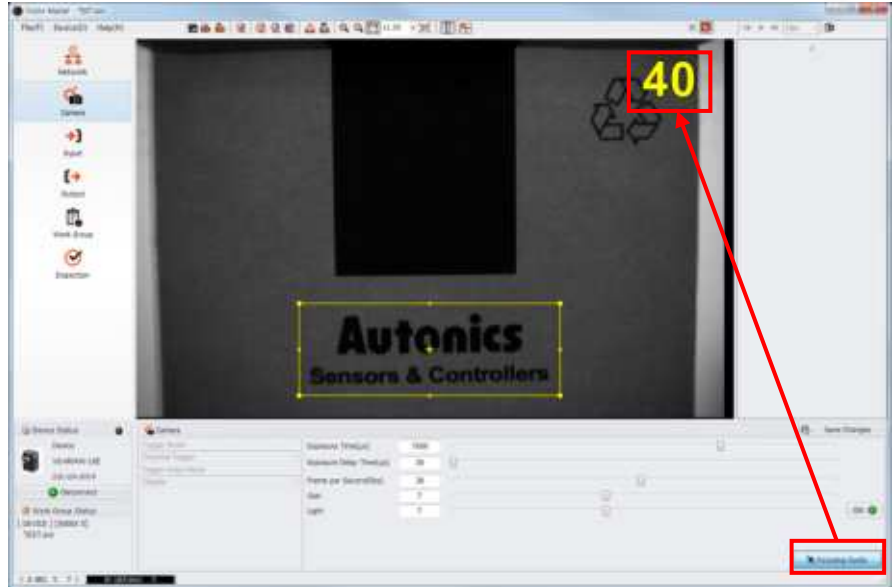

- 3rd If taken images are dark, set the exposure time longer or light level and gain higher.

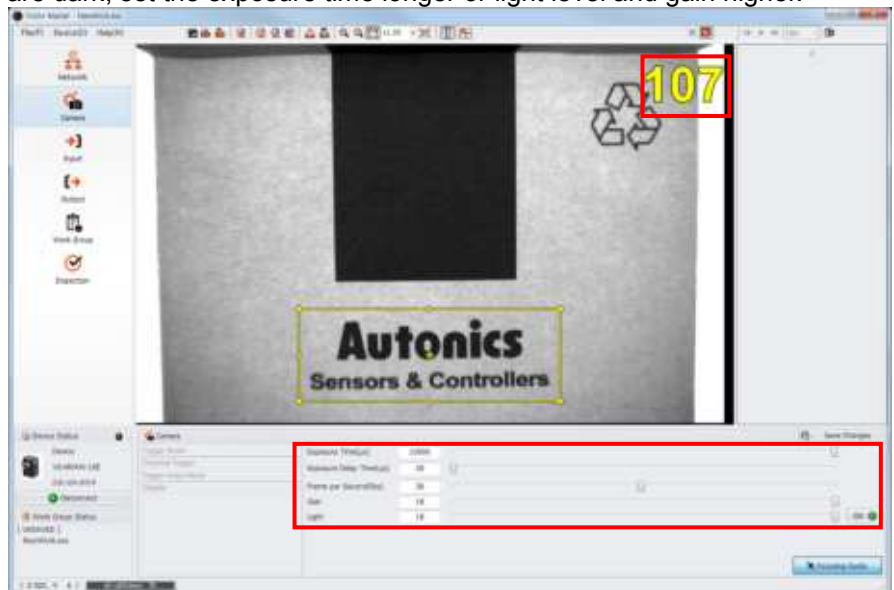

4th Select the type of input signal which performs as a camera shutter to take image by setting the trigger mode.



Camera

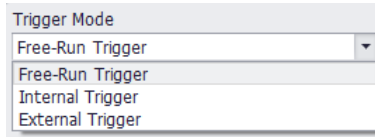

5th Set input and output.



Input



Output



6th Add work in the 'work group' setting. For more details, refer to '6.6.5 Work Group'.



Work group

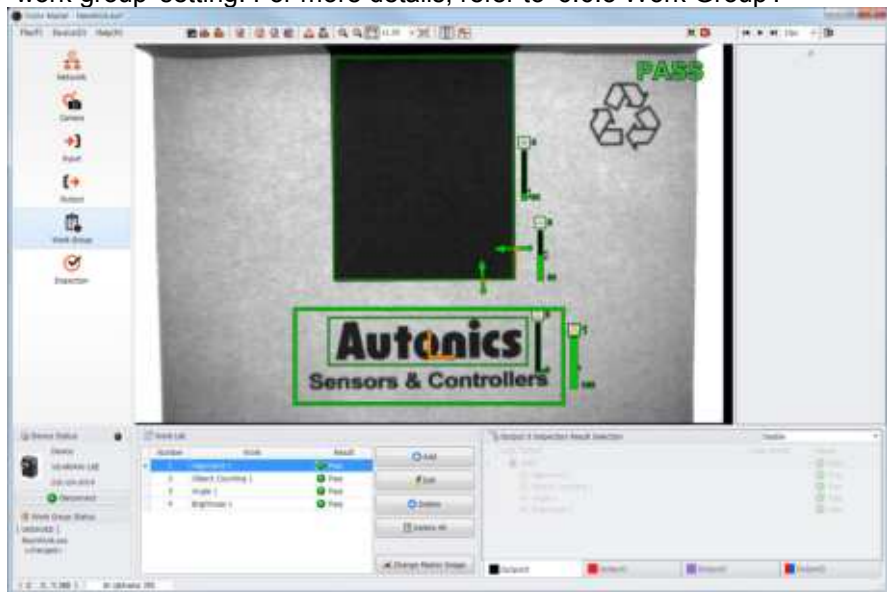

7th Before starting inspection, set the result image which is displayed in the image window, and activate Save result image. For more details, refer to '(1) Device' in '6.6.6 Inspection'.

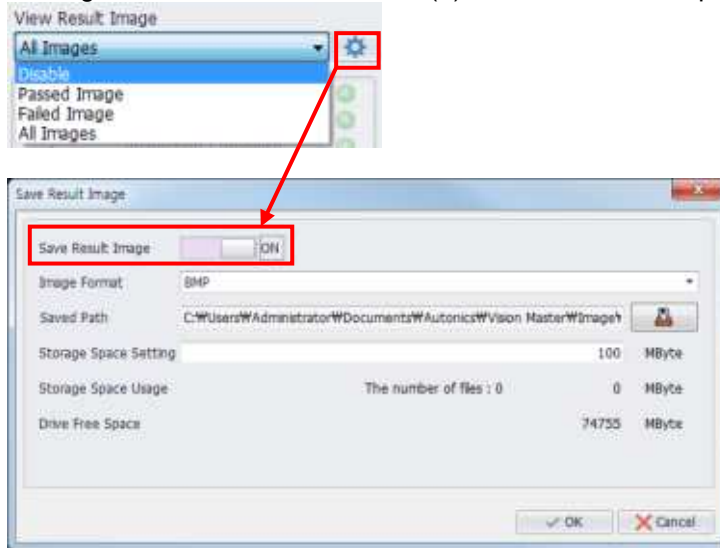

8th Click 'Add taken image to preview window' icon () on the top right side. You can see the images which is being taken by the vision sensor.

9th When you click Start device inspection, Select operation mode window appears. Select between Save and run and Unsave and run for registered work group.

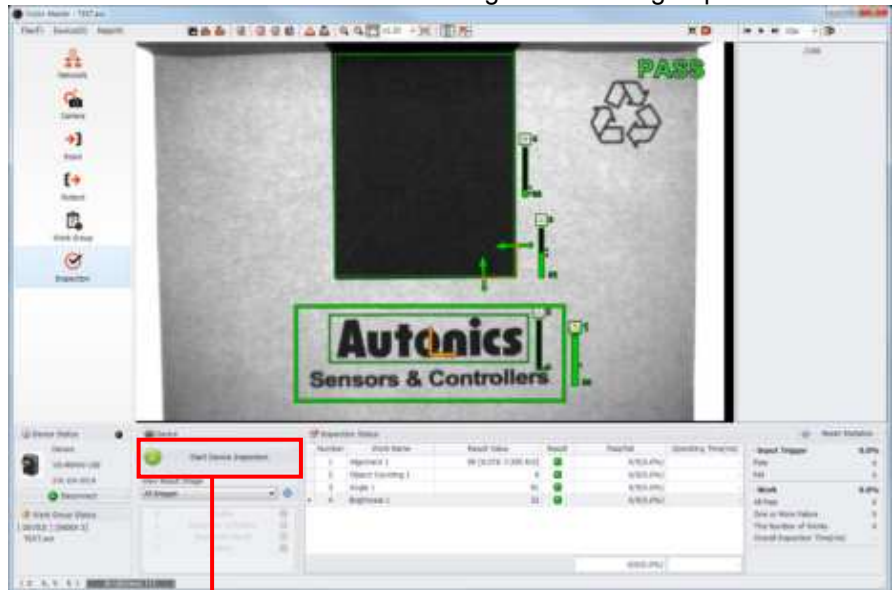

You can also save work group in the File menu to start inspection.

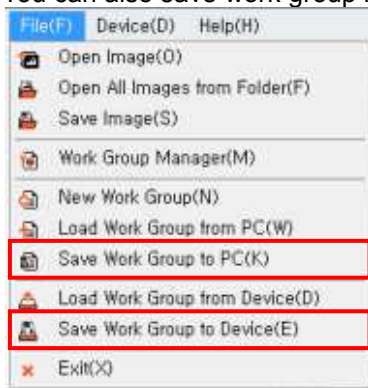

10th Monitor inspection status.



Inspection

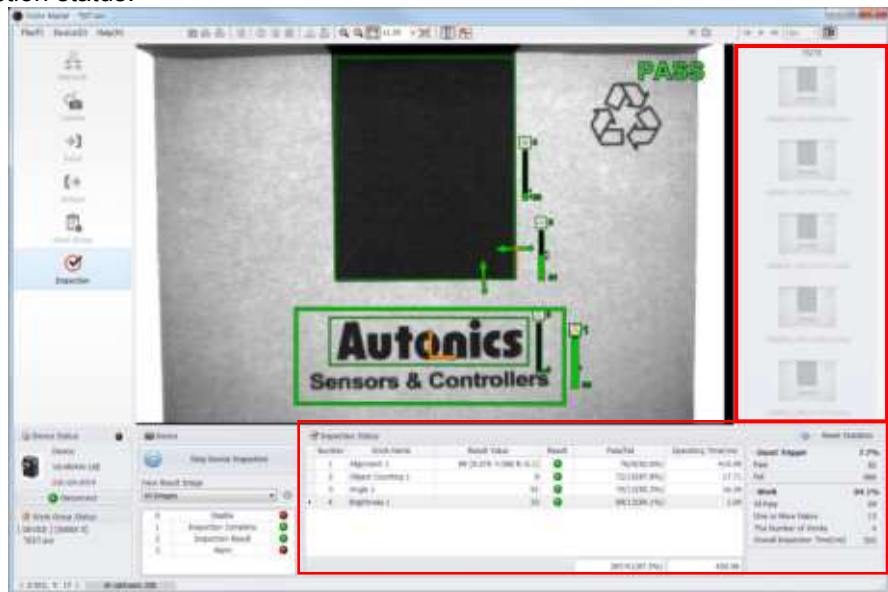

8 Troubleshooting

Please check routinely whether VG is operating in normal status or not.

No	Symptom	Solution
1	When supplying power, POWER LED of VG is not turned on.	Check that status of power supplying and power cable connections is in normal.
		Check that power is being supplied within the rated range.
		Check that polarity of power is connected correctly.
		Check that power terminal is tightened thoroughly.
2	VG does not work due to the external input error.	Check that whether status of input COMMON or each of input wire connection is in normal.
		Check that the device connected to input has a problem.
3	VG does not work due to the external output error.	Check that output wire is connected correctly.
		Check that power to output is being supplied within the rated range.
		Check that the device connected to output has a problem.
		Check that specifications of load connected to output is within the rated range.
4	Error occurs in Ethernet communication.	Check that LINK LED is turned on. If not, check wiring.
		Check that communication (IP address, subnet mask, and gateway) is set correctly. Refer to '6.3.5 Network setting' to set correctly.
		Check that connection or specification of the communication cable is corresponding to that of Autonics guide. Use the Autonics cable (sold separately).

Autonics

Sensors & Controllers

www.autonics.com

Distributor



■ Major Products

·Photoelectric Sensors·Fiber Optic Sensors·Door Sensors·Door Side Sensors·Area Sensors
·Proximity Sensors·Pressure Sensors·Connectors·Sockets·Rotary Encoders·Panel Meters
·Counters·Timers·Temperature Controllers·SSRs/Power Controllers·Sensor Controllers
·Graphic/Logic Panels·Temperature/Humidity Transducers·Switching Mode Power Supplies
·Stepper Motors/Drivers/Motion Controllers·I/O Terminal Blocks & Cables·Display Units
·Control Switches/Lamps/Buzzers·Field Network Devices·Tachometer/Pulse(Rate) Meters
·Laser Marking System(Fiber, CO₂, Nd:YAG)·Laser Welding/Cutting System

■ Any proposal for a product improvement and development: Product@autonics.com

■ Corporate Headquarters

18, Bansong-ro 513 Beon-gil, Haeundae-gu, Busan, South Korea 48002

■ Brazil - Autonics do Brasil Comercial Importadora e Exportadora LTDA

Tel: 55-11-2307-8480 / 3195-4610 / Fax: 55-11-2309-7784 / E-mail: comercial@autonics.com.br

■ China - Autonics electronic(Jiaxing) Corporation

Tel: 86-21-5422-5969 / Fax: 86-21-5422-5961 / E-mail: china@autonics.com

■ India - Autonics Automation India Private Limited

Tel: 91-22-2768-2570 / E-mail: india@autonics.com

■ Indonesia - PT. Autonics Indonesia

Tel: 62-21-8088-8814/5 / Fax: 62-21-8088-4442/0 / E-mail: indonesia@autonics.com

■ Iran - Autonics Corp. Iran Representative Office

Tel: 98-21-8872-7251/2 / Fax: 98-21-8872-8556 / E-mail: iran@autonics.com

■ Japan - Autonics Japan Corporation

Tel: 81-3-6435-8380 / Fax: 81-3-6435-8381 / E-mail: ja@autonics.com

■ Malaysia - Mal.Autonics Sensor Sdn. Bhd.

Tel: 60-3-7805-7190 / Fax: 60-3-7805-7193 / E-mail: malaysia@autonics.com

■ Mexico - Autonics Mexico S.A. DE C.V

Tel: 52-55-5207-0019 / Fax: 52-55-1663-0712 / E-mail: ventas@autonics.com.mx

■ Russia - Autonics Rus LLC

Tel/Fax: 7-495-660-10-88 / E-mail: russia@autonics.com

■ Turkey - Autonics Otomasyon Ticaret Ltd. Sti.

Tel: 90-216-365-9117/3/4 / Fax: 90-216-365-9112 / E-mail: turkey@autonics.com

■ USA - Autonics USA, Inc.

Tel: 1-847-680-8160 / Fax: 1-847-680-8155 / E-mail: sales@autonicsusa.net

■ Vietnam - Cong Ty TNHH Autonics Vina

Tel: 84-28-3771-2662 / Fax: 84-28-3771-2663 / E-mail: vietnam@autonics.com